

Quick Start Guide



EMI Test Receiver

R&S® ESL3

1300.5001K03

1300.5001K13

R&S® ESL6

1300.5001K06

1300.5001K16



The firmware of the instrument makes use of several valuable open source software packages. The most important of them are listed below together with their corresponding open source license. The verbatim license texts are provided in on the user documentation CD-ROM (included in delivery).

Package	Link	License
Net-SNMP	http://www.net-snmp.org	NetSnmp-5.0.8
Xitami	http://www.xitami.com	2.5b6
PHP	http://www.php.net	PHP, Version 3
DOJO-AJAX	http://www.dojotoolkit.org	Academic Free License
OpenSSL	http://www.openssl.org	OpenSSL
ResizableLib	http://www.geocities.com/ppescher	Artistic License
BOOST Library	http://www.boost.org	Boost Software, v.1
zlib	http://www.zlib.net	zlib, v.1.2.3
Xalan Xerces	http://xalan.apache.org/ http://xerces.apache.org/	Apache, Ver.2
ACE	http://www.cs.wustl.edu/~schmidt/ACE.html	ACE_TAO
TAO (The ACE ORB)	http://www.cs.wustl.edu/~schmidt/TAO.html	ACE_TAO
PC/SC-Lite	http://www.linuxnet.com/	PCSCLite
ONC/RPC	http://www.plt.rwth-aachen.de/index.php?id=258	SUN

The OpenSSL Project for use in the OpenSSL Toolkit (<http://www.openssl.org/>), includes cryptographic software written by Eric Young (eay@cryptsoft.com) and software written by Tim Hudson (tjh@cryptsoft.com).

Rohde & Schwarz would like to thank the open source community for their valuable contribution to embedded computing.

Throughout this manual, the Spectrum Analyzer R&S® FSL is abbreviated as R&S FSL.

R&S® is a registered trademark of Rohde & Schwarz GmbH & Co. KG
Trade names are trademarks of the owners

Contents

Safety Instructions
 Customer Information Regarding Product Disposal
 Safety Regulations for Batteries
 Certificate of Quality
 EC Certificate of Conformity
 Support Center Address
 List of R&S Representatives
 Documentation Overview

1	Front and Rear Panel.....	1.1
	Front Panel View.....	1.2
	Function Keys on the Front Panel	1.4
	Connectors on the Front Panel	1.6
	Standard Front Panel Connectors.....	1.6
	Optional Front Panel Connectors.....	1.7
	Rear Panel View.....	1.8
	Connectors on the Rear Panel	1.10
	Standard Rear Panel Connectors.....	1.10
	Optional Rear Panel Connectors.....	1.11
2	Preparing for Use	2.1
	Preparing for Operation.....	2.2
	Unpacking the Instrument and its Accessories.....	2.3
	Checking the Accessories.....	2.4
	Ship Damage Inspection	2.4
	Warranty.....	2.4
	Recommended Calibration Interval	2.4
	Preparing the Instrument for Operation.....	2.5
	Standalone Operation.....	2.5
	Rackmounting.....	2.5
	Power Supply Options.....	2.6
	Instrument modes.....	2.6
	Behavior of the ON/STANDBY key.....	2.6
	Connecting the AC Power	2.7
	Switching On the Instrument.....	2.8

To switch on the instrument	2.8
Performing a Self Alignment and a Self Test	2.8
To perform a self alignment	2.8
To perform a self test	2.8
Checking the Furnished Items	2.9
To check the installed options	2.9
Switching Off the Instrument.....	2.10
To switch to standby mode	2.10
To change into off mode	2.10
Replacing the Fuses	2.11
To replace the fuses.....	2.11
Charging the Battery Pack (Option R&S FSL–B31).....	2.11
Cleaning the Outside	2.12
Connecting External Devices.....	2.12
Connecting USB Devices.....	2.13
Connecting an External Monitor.....	2.14
R&S ESL Setup	2.15
Selecting the Frequency Reference.....	2.15
Setting the Date and Time	2.15
To open the Date and Time Properties dialog box.....	2.15
To change the date	2.16
To change the time	2.16
Configuring the GPIB Interface (Option R&S FSL–B10).....	2.16
To display the GPIB submenu	2.16
To set the GPIB address.....	2.17
To set the ID response string	2.17
Setting the Screen Colors	2.17
To display the screen colors submenu.....	2.17
To use the default color settings	2.17
To use the predefined color set.....	2.18
To define and use your own color set	2.19
Setting the Automatic Display Off Function.....	2.20
To activate automatic display off.....	2.20
To deactivate automatic display off.....	2.20
Selecting and Configuring Printers	2.21
To configure the printer and the printout	2.21
To select the printout colors	2.22

Configuring the LAN Interface	2.23
Connecting the Instrument to the Network	2.23
Configuring the Network Card	2.23
Changing the IP address and configuring the network protocols (TCP/IP protocol).....	2.23
To display the network address submenu	2.24
To configure the network protocol in a network without DHCP server	2.24
To configure the network protocol in a network with DHCP server.....	2.24
Operating System Properties	2.24
Windows XP Software Approved for the R&S ESL	2.25
Windows XP Service Packs	2.26
Login	2.26
Windows XP Start Menu	2.26
To open the Windows XP Start menu.....	2.26
To return to the measurement screen	2.26
3 Firmware Update and Installation of Firmware Options	3.1
Firmware Update	3.2
To update the firmware.....	3.2
To update the firmware (via Windows XP)	3.3
Firmware Options	3.3
To activate firmware options.....	3.3
4 Basic Operations	4.1
Information in the Diagram Area	4.2
Display of Hardware Settings in receiver mode.....	4.4
Display of Hardware Settings in analyzer mode.....	4.5
Status Displays.....	4.6
Trace Information	4.7
Enhancement Labels.....	4.8
Setting Parameters	4.9
Keypad	4.9
Rotary Knob	4.10
Arrow and Position Keys	4.11
Softkeys	4.12
Dialog Boxes	4.13
To enter numeric parameters	4.13
To enter alphanumeric parameters.....	4.13

To navigate in dialog boxes	4.15
Specialties in Windows dialog boxes	4.18
How to Use the Help System.....	4.19
To call context-sensitive and non context-sensitive help	4.19
To navigate in the table of contents	4.19
To navigate in the help topics (with front panel keys).....	4.19
To search for a topic	4.19
To change the zoom	4.20
To close the help window	4.20
5 Basic Measurement Examples.....	5.1
Performing a Level and Frequency Measurement	5.2
Measuring a Sinusoidal Signal	5.7
Measuring the Level and Frequency Using Markers.....	5.7
Increasing the Frequency Resolution.....	5.8
Setting the Reference Level.....	5.9
Measuring the Signal Frequency Using the Frequency Counter.....	5.10
Measuring Harmonics of Sinusoidal Signals	5.12
Measuring the Suppression of the First and Second Harmonic of an Input Signal	5.12
Reducing Noise.....	5.13
Measuring Signal Spectra with Multiple Signals.....	5.15
Separating Signals by Selecting the Resolution Bandwidth.....	5.15
Separating Two Signals with a Level of -30 dBm each at a Frequency	
Spacing of 30 kHz.....	5.16
Measuring the Modulation Depth of an AM-Modulated Carrier (Span > 0)	5.19
Measuring of AM-Modulated Signals	5.21
Displaying the AF of an AM-Modulated Signal (Zero Span).....	5.21
Measurements in Zero Span	5.22
Measuring the Power Characteristic of Burst Signals	5.23
Measuring the Power of a GSM Burst During the Activation Phase.....	5.23
Measuring the Edges of a GSM Burst with High Time Resolution	5.24
Measuring the Signal-to-Noise Ratio of Burst Signals.....	5.26
Signal-to-Noise Ratio of a GSM Signal.....	5.27
Measuring of FM-Modulated Signals	5.29
Displaying the AF of an FM-Modulated Carrier	5.30
Storing and Loading Instrument Settings.....	5.32
Storing an Instrument Configuration (without Traces).....	5.33
Storing Traces	5.34

Loading an Instrument Configuration (with Traces).....	5.34
Configuring Automatic Loading	5.35
6 Brief Introduction to Remote Control.....	6.1
Basic Steps in Remote Control Programming.....	6.2
Linking the Remote Control Library for Visual Basic	6.2
Initialization and Default State.....	6.5
Creating Global Variables.....	6.5
Initializing the Remote Control Session	6.5
Initializing the Instrument.....	6.6
Switching the Screen Display On and Off.....	6.6
Configuring the Power Save Function for the Display	6.7
Sending Simple Instrument Setting Commands.....	6.7
Switching to Manual Operation	6.7
Reading Out Instrument Settings	6.8
Marker Positioning and Readout	6.8
Command Synchronization	6.9
Reading Output Buffers	6.10
Reading Error Messages	6.10
Detailed Programming Examples.....	6.10
Default Setting of the R&S ESL.....	6.10
Setting the Remote Control Status Registers	6.11
Default Settings for Measurements	6.11
Using Markers and Delta Markers.....	6.13
Marker Search Functions, Restricting the Search Range.....	6.13
Frequency Counting	6.15
Working with a Fixed Reference Point.....	6.15
Measuring Noise and Phase Noise	6.16
Reading Out Trace Data	6.18
Storing and Loading Instrument Settings	6.19
Storing Instrument Settings	6.20
Loading Instrument Settings.....	6.20
Setting the Data Record for Startup Recall.....	6.21
Configuring and Starting a Printout	6.21
Appendix A: Printer Interface.....	A.1
Installing Local Printers	A.1
To install a local printer.....	A.1

Appendix B: LAN Interface	B.1
Configuring the Network	B.1
To change the computer name	B.2
To change the domain or workgroup.....	B.2
To operate the instrument without a network	B.3
To create users	B.3
To change the user password.....	B.5
To log on to the network.....	B.6
To deactivate the automatic login mechanism	B.6
To reactivate the automatic login mechanism	B.6
To map network drives.....	B.7
To disconnect network drives.....	B.8
To install a network printer	B.8
To share directories (only with Microsoft networks)	B.13
Remote Operation with XP Remote Desktop.....	B.14
To configure the R&S ESL for remote operation.....	B.14
To configure the controller	B.17
To set up a connection to the R&S ESL.....	B.21
To end Remote Desktop control	B.23
To restore the connection to the R&S ESL	B.24
To deactivate the R&S ESL via remote operation.....	B.24
RSIB Protocol	B.24

Grouped Safety Messages









Make sure to read through and observe the following safety instructions!







All plants and locations of the Rohde & Schwarz group of companies make every effort to keep the safety standard of our products up to date and to offer our customers the highest possible degree of safety. Our products and the auxiliary equipment required for them are designed and tested in accordance with the relevant safety standards. Compliance with these standards is continuously monitored by our quality assurance system. The product described here has been designed and tested in accordance with the EC Certificate of Conformity and has left the manufacturer's plant in a condition fully complying with safety standards. To maintain this condition and to ensure safe operation, observe all instructions and warnings provided in this manual. If you have any questions regarding these safety instructions, the Rohde & Schwarz group of companies will be happy to answer them.

Furthermore, it is your responsibility to use the product in an appropriate manner. This product is designed for use solely in industrial and laboratory environments or, if expressly permitted, also in the field and must not be used in any way that may cause personal injury or property damage. You are responsible if the product is used for an intention other than its designated purpose or in disregard of the manufacturer's instructions. The manufacturer shall assume no responsibility for such use of the product.

The product is used for its designated purpose if it is used in accordance with its product documentation and within its performance limits (see data sheet, documentation, the following safety instructions). Using the product requires technical skills and a basic knowledge of English. It is therefore essential that only skilled and specialized staff or thoroughly trained personnel with the required skills be allowed to use the product. If personal safety gear is required for using Rohde & Schwarz products, this will be indicated at the appropriate place in the product documentation. Keep the basic safety instructions and the product documentation in a safe place and pass them on to the subsequent users.

Symbols and safety labels

							
Observe product documentation	Weight indication for units >18 kg	Danger of electric shock	Warning! Hot surface	PE terminal	Ground	Ground terminal	Attention! Electrostatic sensitive devices

					
Supply voltage ON/OFF	Standby indication	Direct current (DC)	Alternating current (AC)	Direct/alternating current (DC/AC)	Device fully protected by double/reinforced insulation

Observing the safety instructions will help prevent personal injury or damage of any kind caused by dangerous situations. Therefore, carefully read through and adhere to the following safety instructions before putting the product into operation. It is also absolutely essential to observe the additional safety instructions on personal safety that appear in relevant parts of the product documentation. In these safety instructions, the word "product" refers to all merchandise sold and distributed by the Rohde & Schwarz group of companies, including instruments, systems and all accessories.

Tags and their meaning

DANGER	DANGER indicates a hazardous situation which, if not avoided, will result in death or serious injury.
WARNING	WARNING indicates a hazardous situation which, if not avoided, could result in death or serious injury.
CAUTION	CAUTION indicates a hazardous situation which, if not avoided, may result in minor or moderate injury.
NOTICE	NOTICE indicates a property damage message. In the product documentation, the word ATTENTION is used synonymously.

These tags are in accordance with the standard definition for civil applications in the European Economic Area. Definitions that deviate from the standard definition may also exist in other economic areas or military applications. It is therefore essential to make sure that the tags described here are always used only in connection with the related product documentation and the related product. The use of tags in connection with unrelated products or documentation can result in misinterpretation and thus contribute to personal injury or material damage.

Basic safety instructions

1. The product may be operated only under the operating conditions and in the positions specified by the manufacturer. Its ventilation must not be obstructed during operation. Unless otherwise specified, the following requirements apply to Rohde & Schwarz products: prescribed operating position is always with the housing floor facing down, IP protection 2X, pollution severity 2, overvoltage category 2, use only in enclosed spaces, max. operation altitude 2000 m above sea level, max. transport altitude 4500 m above sea level.
A tolerance of $\pm 10\%$ shall apply to the nominal voltage and of $\pm 5\%$ to the nominal frequency.
2. Applicable local or national safety regulations and rules for the prevention of accidents must be observed in all work performed. The product may be opened only by authorized, specially trained personnel. Prior to performing any work on the product or opening the product, the product must be disconnected from the supply network. Any adjustments, replacements of parts, maintenance or repair must be carried out only by technical personnel authorized by Rohde & Schwarz. Only original parts may be used for replacing parts relevant to safety (e.g. power switches, power transformers, fuses). A safety test must always be performed after parts relevant to safety have been replaced (visual inspection, PE conductor test, insulation resistance measurement, leakage current measurement, functional test).

Grouped Safety Messages

3. As with all industrially manufactured goods, the use of substances that induce an allergic reaction (allergens, e.g. nickel) such as aluminum cannot be generally excluded. If you develop an allergic reaction (such as a skin rash, frequent sneezing, red eyes or respiratory difficulties), consult a physician immediately to determine the cause.
4. If products/components are mechanically and/or thermally processed in a manner that goes beyond their intended use, hazardous substances (heavy-metal dust such as lead, beryllium, nickel) may be released. For this reason, the product may only be disassembled, e.g. for disposal purposes, by specially trained personnel. Improper disassembly may be hazardous to your health. National waste disposal regulations must be observed.
5. If handling the product yields hazardous substances or fuels that must be disposed of in a special way, e.g. coolants or engine oils that must be replenished regularly, the safety instructions of the manufacturer of the hazardous substances or fuels and the applicable regional waste disposal regulations must be observed. Also observe the relevant safety instructions in the product documentation.
6. Depending on the function, certain products such as RF radio equipment can produce an elevated level of electromagnetic radiation. Considering that unborn life requires increased protection, pregnant women should be protected by appropriate measures. Persons with pacemakers may also be endangered by electromagnetic radiation. The employer/operator is required to assess workplaces where there is a special risk of exposure to radiation and, if necessary, take measures to avert the danger.
7. Operating the products requires special training and intense concentration. Make certain that persons who use the products are physically, mentally and emotionally fit enough to handle operating the products; otherwise injuries or material damage may occur. It is the responsibility of the employer to select suitable personnel for operating the products.
8. Prior to switching on the product, it must be ensured that the nominal voltage setting on the product matches the nominal voltage of the AC supply network. If a different voltage is to be set, the power fuse of the product may have to be changed accordingly.
9. In the case of products of safety class I with movable power cord and connector, operation is permitted only on sockets with earthing contact and protective earth connection.
10. Intentionally breaking the protective earth connection either in the feed line or in the product itself is not permitted. Doing so can result in the danger of an electric shock from the product. If extension cords or connector strips are implemented, they must be checked on a regular basis to ensure that they are safe to use.
11. If the product has no power switch for disconnection from the AC supply, the plug of the connecting cable is regarded as the disconnecting device. In such cases, it must be ensured that the power plug is easily reachable and accessible at all times (corresponding to the length of connecting cable, approx. 2 m). Functional or electronic switches are not suitable for providing disconnection from the AC supply. If products without power switches are integrated in racks or systems, a disconnecting device must be provided at the system level.

Grouped Safety Messages

12. Never use the product if the power cable is damaged. Check the power cable on a regular basis to ensure that it is in proper operating condition. By taking appropriate safety measures and carefully laying the power cable, ensure that the cable cannot be damaged and that no one can be hurt by e.g. tripping over the cable or suffering an electric shock.
13. The product may be operated only from TN/TT supply networks fused with max. 16 A (higher fuse only after consulting with the Rohde & Schwarz group of companies).
14. Do not insert the plug into sockets that are dusty or dirty. Insert the plug firmly and all the way into the socket. Otherwise, this can result in sparks, fire and/or injuries.
15. Do not overload any sockets, extension cords or connector strips; doing so can cause fire or electric shocks.
16. For measurements in circuits with voltages $V_{\text{rms}} > 30 \text{ V}$, suitable measures (e.g. appropriate measuring equipment, fusing, current limiting, electrical separation, insulation) should be taken to avoid any hazards.
17. Ensure that the connections with information technology equipment comply with IEC 950/EN 60950.
18. Unless expressly permitted, never remove the cover or any part of the housing while the product is in operation. Doing so will expose circuits and components and can lead to injuries, fire or damage to the product.
19. If a product is to be permanently installed, the connection between the PE terminal on site and the product's PE conductor must be made first before any other connection is made. The product may be installed and connected only by a license electrician.
20. For permanently installed equipment without built-in fuses, circuit breakers or similar protective devices, the supply circuit must be fused in such a way that suitable protection is provided for users and products.
21. Do not insert any objects into the openings in the housing that are not designed for this purpose. Never pour any liquids onto or into the housing. This can cause short circuits inside the product and/or electric shocks, fire or injuries.
22. Use suitable overvoltage protection to ensure that no overvoltage (such as that caused by a thunderstorm) can reach the product. Otherwise the operating personnel will be endangered by electric shocks.
23. Rohde & Schwarz products are not protected against penetration of liquids, unless otherwise specified (see also safety instruction 1.). If this is not taken into account, there exists the danger of electric shock for the user or damage to the product, which can also lead to personal injury.
24. Never use the product under conditions in which condensation has formed or can form in or on the product, e.g. if the product was moved from a cold to a warm environment.
25. Do not close any slots or openings on the product, since they are necessary for ventilation and prevent the product from overheating. Do not place the product on soft surfaces such as sofas or rugs or inside a closed housing, unless this is well ventilated.
26. Do not place the product on heat-generating devices such as radiators or fan heaters. The temperature of the environment must not exceed the maximum temperature specified in the data sheet.
27. Batteries and storage batteries must not be exposed to high temperatures or fire. Keep batteries and storage batteries away from children. Do not short-circuit batteries and storage batteries. If batteries or storage batteries are improperly replaced, this can cause an explosion (warning: lithium cells).

Grouped Safety Messages

- Replace the battery or storage battery only with the matching Rohde & Schwarz type (see spare parts list). Batteries and storage batteries must be recycled and kept separate from residual waste. Batteries and storage batteries that contain lead, mercury or cadmium are hazardous waste. Observe the national regulations regarding waste disposal and recycling.
28. Please be aware that in the event of a fire, toxic substances (gases, liquids etc.) that may be hazardous to your health may escape from the product.
 29. The product can be very heavy. Be careful when moving it to avoid back or other physical injuries.
 30. Do not place the product on surfaces, vehicles, cabinets or tables that for reasons of weight or stability are unsuitable for this purpose. Always follow the manufacturer's installation instructions when installing the product and fastening it to objects or structures (e.g. walls and shelves).
 31. Handles on the products are designed exclusively for personnel to hold or carry the product. It is therefore not permissible to use handles for fastening the product to or on means of transport such as cranes, fork lifts, wagons, etc. The user is responsible for securely fastening the products to or on the means of transport and for observing the safety regulations of the manufacturer of the means of transport. Noncompliance can result in personal injury or material damage.
 32. If you use the product in a vehicle, it is the sole responsibility of the driver to drive the vehicle safely. Adequately secure the product in the vehicle to prevent injuries or other damage in the event of an accident. Never use the product in a moving vehicle if doing so could distract the driver of the vehicle. The driver is always responsible for the safety of the vehicle. The manufacturer assumes no responsibility for accidents or collisions.
 33. If a laser product (e.g. a CD/DVD drive) is integrated in a Rohde & Schwarz product, do not use any other settings or functions than those described in the product documentation. Otherwise this may be hazardous to your health, since the laser beam can cause irreversible damage to your eyes. Never try to take such products apart, and never look into the laser beam.
 34. Prior to cleaning, disconnect the product from the AC supply. Use a soft, non-linting cloth to clean the product. Never use chemical cleaning agents such as alcohol, acetone or diluent for cellulose lacquers.

Informaciones elementales de seguridad

¡Es imprescindible leer y observar las siguientes instrucciones e informaciones de seguridad!

El principio del grupo de empresas Rohde & Schwarz consiste en tener nuestros productos siempre al día con los estándares de seguridad y de ofrecer a nuestros clientes el máximo grado de seguridad. Nuestros productos y todos los equipos adicionales son siempre fabricados y examinados según las normas de seguridad vigentes. Nuestra sección de gestión de la seguridad de calidad controla constantemente que sean cumplidas estas normas. El presente producto ha sido fabricado y examinado según el comprobante de conformidad adjunto según las normas de la CE y ha salido de nuestra planta en estado impecable según los estándares técnicos de seguridad. Para poder preservar este estado y garantizar un funcionamiento libre de peligros, el usuario deberá atenerse a todas las indicaciones, informaciones de seguridad y notas de alerta. El grupo de empresas Rohde & Schwarz está siempre a su disposición en caso de que tengan preguntas referentes a estas informaciones de seguridad.







Además queda en la responsabilidad del usuario utilizar el producto en la forma debida. Este producto está destinado exclusivamente al uso en la industria y el laboratorio o, si ha sido expresamente autorizado, para aplicaciones de campo y de ninguna manera deberá ser utilizado de modo que alguna persona/cosa pueda sufrir daño. El uso del producto fuera de sus fines definidos o despreciando las informaciones de seguridad del fabricante queda en la responsabilidad del usuario. El fabricante no se hace en ninguna forma responsable de consecuencias a causa del mal uso del producto.

Se parte del uso correcto del producto para los fines definidos si el producto es utilizado dentro de las instrucciones de la correspondiente documentación de producto y dentro del margen de rendimiento definido (ver hoja de datos, documentación, informaciones de seguridad que siguen). El uso del producto hace necesarios conocimientos profundos y conocimientos básicas del idioma inglés. Por eso se debe tener en cuenta que el producto sólo pueda ser operado por personal especializado o personas minuciosamente instruidas con las capacidades correspondientes. Si fuera necesaria indumentaria de seguridad para el uso de productos de R&S, encontrará la información debida en la documentación del producto en el capítulo correspondiente. Guarde bien las informaciones de seguridad elementales, así como la documentación del producto y entréguela a usuarios posteriores.

Símbolos y definiciones de seguridad

							
Ver documentación de producto	Informaciones para maquinaria con un peso de > 18kg	Peligro de golpe de corriente	¡Advertencia! Superficie caliente	Conexión a conductor protector	Conexión a tierra	Conexión a masa conductora	¡Cuidado! Elementos de construcción con peligro de carga electroestática

Informaciones elementales de seguridad

					
Potencia EN MARCHA/PARADA	Indicación Stand-by	Corriente continua DC	Corriente alterna AC	Corriente continua/alterna DC/AC	El aparato está protegido en su totalidad por un aislamiento de doble refuerzo

Tener en cuenta las informaciones de seguridad sirve para tratar de evitar daños y peligros de toda clase. Es necesario de que se lean las siguientes informaciones de seguridad concienzudamente y se tengan en cuenta debidamente antes de la puesta en funcionamiento del producto. También deberán ser tenidas en cuenta las informaciones para la protección de personas que encontrarán en el capítulo correspondiente de la documentación de producto y que también son obligatorias de seguir. En las informaciones de seguridad actuales hemos juntado todos los objetos vendidos por el grupo de empresas Rohde & Schwarz bajo la denominación de „producto“, entre ellos también aparatos, instalaciones así como toda clase de accesorios.

Palabras de señal y su significado

PELIGRO	Identifica un peligro directo con riesgo elevado de provocar muerte o lesiones de gravedad si no se toman las medidas oportunas.
ADVERTENCIA	Identifica un posible peligro con riesgo medio de provocar muerte o lesiones (de gravedad) si no se toman las medidas oportunas.
ATENCIÓN	Identifica un peligro con riesgo reducido de provocar lesiones de gravedad media o leve si no se toman las medidas oportunas.
AVISO	Indica la posibilidad de utilizar mal el producto y a consecuencia dañarlo. En la documentación del producto se emplea de forma sinónima el término CUIDADO.

Las palabras de señal corresponden a la definición habitual para aplicaciones civiles en el área económica europea. Pueden existir definiciones diferentes a esta definición en otras áreas económicas o en aplicaciones militares. Por eso se deberá tener en cuenta que las palabras de señal aquí descritas sean utilizadas siempre solamente en combinación con la correspondiente documentación de producto y solamente en combinación con el producto correspondiente. La utilización de las palabras de señal en combinación con productos o documentaciones que no les correspondan puede llevar a malinterpretaciones y tener por consecuencia daños en personas u objetos.

Informaciones de seguridad elementales

1. El producto solamente debe ser utilizado según lo indicado por el fabricante referente a la situación y posición de funcionamiento sin que se obstruya la ventilación. Si no se convino de otra manera, es para los productos R&S válido lo que sigue:
como posición de funcionamiento se define por principio la posición con el suelo de la caja para abajo, modo de protección IP 2X, grado de suciedad 2, categoría de sobrecarga eléctrica 2, utilizar solamente en estancias interiores, utilización hasta 2000 m sobre el nivel del mar, transporte hasta 4.500 m sobre el nivel del mar. Se aplicará una tolerancia de $\pm 10\%$ sobre el voltaje nominal y de $\pm 5\%$ sobre la frecuencia nominal.
2. En todos los trabajos deberán ser tenidas en cuenta las normas locales de seguridad de trabajo y de prevención de accidentes. El producto solamente debe de ser abierto por personal especializado autorizado. Antes de efectuar trabajos en el producto o abrirlo deberá este ser desconectado de la corriente. El ajuste, el cambio de partes, la manutención y la reparación deberán ser solamente efectuadas por electricistas autorizados por R&S. Si se reponen partes con importancia para los aspectos de seguridad (por ejemplo el enchufe, los transformadores o los fusibles), solamente podrán ser sustituidos por partes originales. Después de cada recambio de partes elementales para la seguridad deberá ser efectuado un control de seguridad (control a primera vista, control de conductor protector, medición de resistencia de aislamiento, medición de la corriente conductora, control de funcionamiento).
3. Como en todo producto de fabricación industrial no puede ser excluido en general de que se produzcan al usarlo elementos que puedan generar alergias, los llamados elementos alergénicos (por ejemplo el níquel). Si se produjeran en el trato con productos R&S reacciones alérgicas, como por ejemplo urticaria, estornudos frecuentes, irritación de la conjuntiva o dificultades al respirar, se deberá consultar inmediatamente a un médico para averiguar los motivos de estas reacciones.
4. Si productos / elementos de construcción son tratados fuera del funcionamiento definido de forma mecánica o térmica, pueden generarse elementos peligrosos (polvos de sustancia de metales pesados como por ejemplo plomo, berilio, níquel). La partición elemental del producto, como por ejemplo sucede en el tratamiento de materias residuales, debe de ser efectuada solamente por personal especializado para estos tratamientos. La partición elemental efectuada inadecuadamente puede generar daños para la salud. Se deben tener en cuenta las directivas nacionales referentes al tratamiento de materias residuales.
5. En el caso de que se produjeran agentes de peligro o combustibles en la aplicación del producto que debieran de ser transferidos a un tratamiento de materias residuales, como por ejemplo agentes refrigerantes que deben ser repuestos en periodos definidos, o aceites para motores, deberán ser tenidas en cuenta las prescripciones de seguridad del fabricante de estos agentes de peligro o combustibles y las regulaciones regionales para el tratamiento de materias residuales. Cuiden también de tener en cuenta en caso dado las prescripciones de seguridad especiales en la descripción del producto.

6. Ciertos productos, como por ejemplo las instalaciones de radiocomunicación RF, pueden a causa de su función natural, emitir una radiación electromagnética aumentada. En vista a la protección de la vida en desarrollo deberían ser protegidas personas embarazadas debidamente. También las personas con un bypass pueden correr peligro a causa de la radiación electromagnética. El empresario/usuario está comprometido a valorar y señalar áreas de trabajo en las que se corra un riesgo aumentado de exposición a radiaciones para evitar riesgos.
7. La utilización de los productos requiere instrucciones especiales y una alta concentración en el manejo. Debe de ponerse por seguro de que las personas que manejen los productos estén a la altura de los requerimientos necesarios referente a sus aptitudes físicas, psíquicas y emocionales, ya que de otra manera no se pueden excluir lesiones o daños de objetos. El empresario lleva la responsabilidad de seleccionar el personal usuario apto para el manejo de los productos.
8. Antes de la puesta en marcha del producto se deberá tener por seguro de que la tensión preseleccionada en el producto equivalga a la del la red de distribución. Si es necesario cambiar la preselección de la tensión también se deberán en caso dabo cambiar los fusibles correspondientes del producto.
9. Productos de la clase de seguridad I con alimentación móvil y enchufe individual de producto solamente deberán ser conectados para el funcionamiento a tomas de corriente de contacto de seguridad y con conductor protector conectado.
10. Queda prohibida toda clase de interrupción intencionada del conductor protector, tanto en la toma de corriente como en el mismo producto. Puede tener como consecuencia el peligro de golpe de corriente por el producto. Si se utilizaran cables o enchufes de extensión se deberá poner al seguro que es controlado su estado técnico de seguridad.
11. Si el producto no está equipado con un interruptor para desconectarlo de la red, se deberá considerar el enchufe del cable de distribución como interruptor. En estos casos deberá asegurar de que el enchufe sea de fácil acceso y nabejo (según la medida del cable de distribución, aproximadamente 2 m). Los interruptores de función o electrónicos no son aptos para el corte de la red eléctrica. Si los productos sin interruptor están integrados en bastidores o instalaciones, se deberá instalar el interruptor al nivel de la instalación.
12. No utilice nunca el producto si está dañado el cable eléctrico. Compruebe regularmente el correcto estado de los cables de conexión a red. Asegure a través de las medidas de protección y de instalación adecuadas de que el cable de eléctrico no pueda ser dañado o de que nadie pueda ser dañado por él, por ejemplo al tropezar o por un golpe de corriente.
13. Solamente está permitido el funcionamiento en redes de distribución TN/TT aseguradas con fusibles de como máximo 16 A (utilización de fusibles de mayor amperaje sólo previa consulta con el grupo de empresas Rohde & Schwarz).
14. Nunca conecte el enchufe en tomas de corriente sucias o llenas de polvo. Introduzca el enchufe por completo y fuertemente en la toma de corriente. Si no tiene en consideración estas indicaciones se arriesga a que se originen chispas, fuego y/o heridas.
15. No sobrecargue las tomas de corriente, los cables de extensión o los enchufes de extensión ya que esto pudiera causar fuego o golpes de corriente.

16. En las mediciones en circuitos de corriente con una tensión de entrada de $U_{eff} > 30 \text{ V}$ se deberá tomar las precauciones debidas para impedir cualquier peligro (por ejemplo medios de medición adecuados, seguros, limitación de tensión, corte protector, aislamiento etc.).
17. En caso de conexión con aparatos de la técnica informática se deberá tener en cuenta que estos cumplan los requisitos del estándar IEC950/EN60950.
18. A menos que esté permitido expresamente, no retire nunca la tapa ni componentes de la carcasa mientras el producto esté en servicio. Esto pone a descubierto los cables y componentes eléctricos y puede causar heridas, fuego o daños en el producto.
19. Si un producto es instalado fijamente en un lugar, se deberá primero conectar el conductor protector fijo con el conductor protector del aparato antes de hacer cualquier otra conexión. La instalación y la conexión deberán ser efectuadas por un electricista especializado.
20. En caso de que los productos que son instalados fijamente en un lugar sean sin protector implementado, autointerruptor o similares objetos de protección, el circuito de suministro de corriente deberá estar protegido de manera que usuarios y productos estén suficientemente protegidos.
21. Por favor, no introduzca ningún objeto que no esté destinado a ello en los orificios de la caja del aparato. No vierta nunca ninguna clase de líquidos sobre o en la caja. Esto puede producir cortocircuitos en el producto y/o puede causar golpes de corriente, fuego o heridas.
22. Asegúrese con la protección adecuada de que no pueda originarse en el producto una sobrecarga por ejemplo a causa de una tormenta. Si no se verá el personal que lo utilice expuesto al peligro de un golpe de corriente.
23. Los productos R&S no están protegidos contra líquidos si no es que exista otra indicación, ver también punto 1. Si no se tiene en cuenta esto se arriesga el peligro de golpe de corriente para el usuario o de daños en el producto lo cual también puede llevar al peligro de personas.
24. No utilice el producto bajo condiciones en las que pueda producirse y se hayan producido líquidos de condensación en o dentro del producto como por ejemplo cuando se desplaza el producto de un lugar frío a un lugar caliente.
25. Por favor no cierre ninguna ranura u orificio del producto, ya que estas son necesarias para la ventilación e impiden que el producto se caliente demasiado. No pongan el producto encima de materiales blandos como por ejemplo sofás o alfombras o dentro de una caja cerrada, si esta no está suficientemente ventilada.
26. No ponga el producto sobre aparatos que produzcan calor, como por ejemplo radiadores o calentadores. La temperatura ambiental no debe superar la temperatura máxima especificada en la hoja de datos.
27. Baterías y acumuladores no deben de ser expuestos a temperaturas altas o al fuego. Guardar baterías y acumuladores fuera del alcance de los niños. No cortocircuitar baterías ni acumuladores. Si las baterías o los acumuladores no son cambiados con la debida atención existirá peligro de explosión (atención células de litio). Cambiar las baterías o los acumuladores solamente por los del tipo R&S correspondiente (ver lista de piezas de recambio). Las baterías y acumuladores deben reutilizarse y no deben acceder a los vertederos. Las baterías y acumuladores que contienen plomo, mercurio o cadmio deben tratarse como residuos especiales. Respete en esta relación las normas nacionales de evacuación y reciclaje.
28. Por favor tengan en cuenta que en caso de un incendio pueden desprenderse del producto agentes venenosos (gases, líquidos etc.) que pueden generar daños a la salud.

29. El producto puede poseer un peso elevado. Muévelo con cuidado para evitar lesiones en la espalda u otras partes corporales.
30. No sitúe el producto encima de superficies, vehículos, estantes o mesas, que por sus características de peso o de estabilidad no sean aptas para él. Siga siempre las instrucciones de instalación del fabricante cuando instale y asegure el producto en objetos o estructuras (por ejemplo paredes y estantes).
31. Las asas instaladas en los productos sirven solamente de ayuda para el manejo que solamente está previsto para personas. Por eso no está permitido utilizar las asas para la sujeción en o sobre medios de transporte como por ejemplo grúas, carretillas elevadoras de horquilla, carros etc. El usuario es responsable de que los productos sean sujetados de forma segura a los medios de transporte y de que las prescripciones de seguridad del fabricante de los medios de transporte sean observadas. En caso de que no se tengan en cuenta pueden causarse daños en personas y objetos.
32. Si llega a utilizar el producto dentro de un vehículo, queda en la responsabilidad absoluta del conductor que conducir el vehículo de manera segura. Asegure el producto dentro del vehículo debidamente para evitar en caso de un accidente las lesiones u otra clase de daños. No utilice nunca el producto dentro de un vehículo en movimiento si esto pudiera distraer al conductor. Siempre queda en la responsabilidad absoluta del conductor la seguridad del vehículo. El fabricante no asumirá ninguna clase de responsabilidad por accidentes o colisiones.
33. Dado el caso de que esté integrado un producto de láser en un producto R&S (por ejemplo CD/DVD-ROM) no utilice otras instalaciones o funciones que las descritas en la documentación de producto. De otra manera pondrá en peligro su salud, ya que el rayo láser puede dañar irreversiblemente sus ojos. Nunca trate de descomponer estos productos. Nunca mire dentro del rayo láser.
34. Antes de proceder a la limpieza, desconecte el producto de la red. Realice la limpieza con un paño suave, que no se deshilache. No utilice de ninguna manera agentes limpiadores químicos como, por ejemplo, alcohol, acetona o nitrodiluyente.



ROHDE & SCHWARZ

Kundeninformation zur Batterieverordnung (BattV)

Dieses Gerät enthält eine schadstoffhaltige Batterie.
Diese darf nicht mit dem Hausmüll entsorgt werden.
Nach Ende der Lebensdauer darf die Entsorgung nur
über eine Rohde&Schwarz-Kundendienststelle oder eine
geeignete Sammelstelle erfolgen.

Safety Regulations for Batteries (according to BattV)

This equipment houses a battery containing harmful
substances that must not be disposed of as normal
household waste.
After its useful life, the battery may only be disposed of
at a Rohde & Schwarz service center or at a suitable
depot.

Normas de Seguridad para Baterías (Según BattV)

Este equipo lleva una batería que contiene sustancias
perjudiciales, que no se debe desechar en los
contenedores de basura domésticos.
Después de la vida útil, la batería sólo se podrá eliminar
en un centro de servicio de Rohde & Schwarz o en un
depósito apropiado.

Consignes de sécurité pour batteries (selon BattV)

Cet appareil est équipé d'une pile comprenant des
substances nocives. Ne jamais la jeter dans une
poubelle pour ordures ménagères.
Une pile usagée doit uniquement être éliminée par un
centre de service client de Rohde & Schwarz ou peut
être collectée pour être traitée spécialement comme
déchets dangereux.

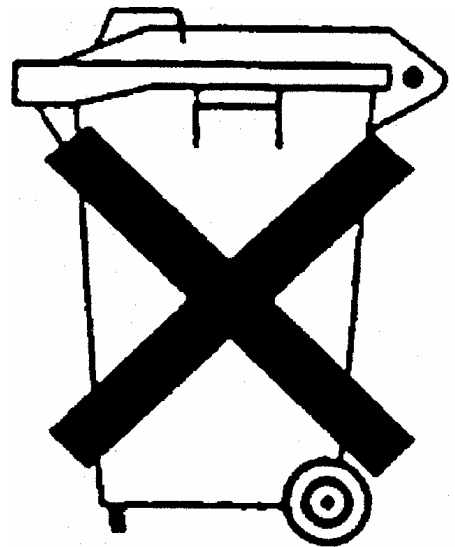

Customer Information Regarding Product Disposal

The German Electrical and Electronic Equipment (ElektroG) Act is an implementation of the following EC directives:

- 2002/96/EC on waste electrical and electronic equipment (WEEE) and
- 2002/95/EC on the restriction of the use of certain hazardous substances in electrical and electronic equipment (RoHS).

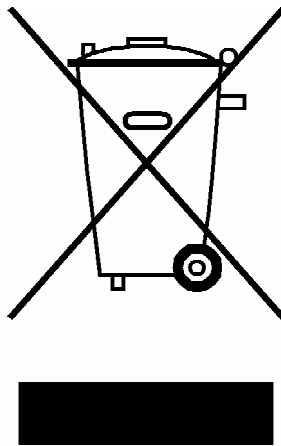

Product labeling in accordance with EN 50419

Once the lifetime of a product has ended, this product must not be disposed of in the standard domestic refuse. Even disposal via the municipal collection points for waste electrical and electronic equipment is not permitted.

Rohde & Schwarz GmbH & Co. KG has developed a disposal concept for the environmental-friendly disposal or recycling of waste material and fully assumes its obligation as a producer to take back and dispose of electrical and electronic waste in accordance with the ElektroG Act.

Please contact your local service representative to dispose of the product.



Certified Quality System

DIN EN ISO 9001 : 2000
DIN EN 9100 : 2003
DIN EN ISO 14001 : 2004

DQS REG. NO 001954 QM UM

QUALITÄTSZERTIFIKAT

Sehr geehrter Kunde,
Sie haben sich für den Kauf eines Rohde & Schwarz-Produktes entschieden. Hiermit erhalten Sie ein nach modernsten Fertigungsmethoden hergestelltes Produkt. Es wurde nach den Regeln unseres Managementsystems entwickelt, gefertigt und geprüft. Das Rohde & Schwarz Managementsystem ist zertifiziert nach:

DIN EN ISO 9001:2000
DIN EN 9100:2003
DIN EN ISO 14001:2004

CERTIFICATE OF QUALITY

Dear Customer,
you have decided to buy a Rohde & Schwarz product. You are thus assured of receiving a product that is manufactured using the most modern methods available. This product was developed, manufactured and tested in compliance with our quality management system standards. The Rohde & Schwarz quality management system is certified according to:

DIN EN ISO 9001:2000
DIN EN 9100:2003
DIN EN ISO 14001:2004

CERTIFICAT DE QUALITÉ

Cher Client,
vous avez choisi d'acheter un produit Rohde & Schwarz. Vous disposez donc d'un produit fabriqué d'après les méthodes les plus avancées. Le développement, la fabrication et les tests respectent nos normes de gestion qualité. Le système de gestion qualité de Rohde & Schwarz a été homologué conformément aux normes:

DIN EN ISO 9001:2000
DIN EN 9100:2003
DIN EN ISO 14001:2004





Certificate No.: 2008-43

This is to certify that:

Equipment type	Stock No.	Designation
ESL3	1300.5001.03/.13	EMI Test Receiver
ESL6	1300.5001.06/.16	
FSL-B4	1300.6008.02	OCXO Reference Frequency
FSL-B5	1300.6108.02	Additional Interfaces
FSL-B8	1300.5701.02	Gated Sweep Function
FSL-B10	1300.6208.02	GPIB Interface
FSL-B22	1300.5953.02	RF Amplifier
FSL-B30	1300.6308.02	DC Power Supply
FSL-B31	1300.6408.02	NIMH Battery Pack
FSL-Z4	1300.5430.02	Additional Charger Unit

complies with the provisions of the Directive of the Council of the European Union on the approximation of the laws of the Member States

- relating to electrical equipment for use within defined voltage limits (2006/95/EC)
- relating to electromagnetic compatibility (2004/108/EC)

Conformity is proven by compliance with the following standards:

EN 61010-1 : 2001
EN 61326 : 1997 + A1 : 1998 + A2 : 2001 + A3 : 2003
EN 55011 : 1998 + A1 : 1999 + A2 : 2002, Klasse B
EN 61000-3-2 : 2000 + A2 : 2005
EN 61000-3-3 : 1995 + A1 : 2001

For the assessment of electromagnetic compatibility, the limits of radio interference for Class B equipment as well as the immunity to interference for operation in industry have been used as a basis.

Affixing the EC conformity mark as from 2008

ROHDE & SCHWARZ GmbH & Co. KG
Mühldorfstr. 15, D-81671 München

Munich, 2008-06-18

Central Quality Management MF-QZ / Radde

Customer Support

Technical support – where and when you need it

For quick, expert help with any Rohde & Schwarz equipment, contact one of our Customer Support Centers. A team of highly qualified engineers provides telephone support and will work with you to find a solution to your query on any aspect of the operation, programming or applications of Rohde & Schwarz equipment.

Up-to-date information and upgrades

To keep your instrument up-to-date and to be informed about new application notes related to your instrument, please send an e-mail to the Customer Support Center stating your instrument and your wish.

We will take care that you will get the right information.

USA & Canada

Monday to Friday	(except US public holidays)
8:00 AM – 8:00 PM	Eastern Standard Time (EST)
Tel. from USA	888-test-rsa (888-837-8772) (opt 2)
From outside USA	+1 410 910 7800 (opt 2)
Fax	+1 410 910 7801
E-mail	CustomerSupport@rohde-schwarz.com

East Asia

Monday to Friday	(except Singaporean public holidays)
8:30 AM – 6:00 PM	Singapore Time (SGT)
Tel.	+65 6 513 0488
Fax	+65 6 846 1090
E-mail	CustomerSupport@rohde-schwarz.com

Rest of the World

Monday to Friday	(except German public holidays)
08:00 – 17:00	Central European Time (CET)
Tel. from Europe	+49 (0) 180 512 42 42*
From outside Europe	+49 89 4129 13776
Fax	+49 (0) 89 41 29 637 78
E-mail	CustomerSupport@rohde-schwarz.com

* 0.14 €/Min within the German fixed-line telephone network, varying prices for the mobile telephone network and in different countries.



Address List

Headquarters, Plants and Subsidiaries

Headquarters

ROHDE & SCHWARZ GmbH & Co. KG
Mühlendorfstraße 15 · D-81671 München
P.O.Box 80 14 69 · D-81614 München

Phone +49 (89) 41 29-0
Fax +49 (89) 41 29-121 64
info.rs@rohde-schwarz.com

Plants

ROHDE & SCHWARZ Messgerätebau GmbH
Riedbachstraße 58 · D-87700 Memmingen
P.O.Box 16 52 · D-87686 Memmingen

Phone +49 (83 31) 1 08-0
+49 (83 31) 1 08-1124
info.rsmb@rohde-schwarz.com

ROHDE & SCHWARZ GmbH & Co. KG
Werk Teisnach
Kaikenrieder Straße 27 · D-94244 Teisnach
P.O.Box 11 49 · D-94240 Teisnach

Phone +49 (99 23) 8 50-0
Fax +49 (99 23) 8 50-174
info.rsdt@rohde-schwarz.com

ROHDE & SCHWARZ závod
Vimperk, s.r.o.
Location Spidrova 49
CZ-38501 Vimperk

Phone +420 (388) 45 21 09
Fax +420 (388) 45 21 13

ROHDE & SCHWARZ GmbH & Co. KG
Dienstleistungszentrum Köln
Graf-Zeppelin-Straße 18 · D-51147 Köln
P.O.Box 98 02 60 · D-51130 Köln

Phone +49 (22 03) 49-0
Fax +49 (22 03) 49 51-229
info.rsd@rohde-schwarz.com
service.rsd@rohde-schwarz.com

Subsidiaries

R&S BICK Mobilfunk GmbH
Fritz-Hahne-Str. 7 · D-31848 Bad Münder
P.O.Box 20 02 · D-31844 Bad Münder

Phone +49 (50 42) 9 98-0
Fax +49 (50 42) 9 98-105
info.bick@rohde-schwarz.com

ROHDE & SCHWARZ FTK GmbH
Wendenschloßstraße 168, Haus 28
D-12557 Berlin

Phone +49 (30) 658 91-122
Fax +49 (30) 655 50-221
info.ftk@rohde-schwarz.com

ROHDE & SCHWARZ SIT GmbH
Am Studio 3
D-12489 Berlin

Phone +49 (30) 658 84-0
Fax +49 (30) 658 84-183
info.sit@rohde-schwarz.com

R&S Systems GmbH
Graf-Zeppelin-Straße 18
D-51147 Köln

Phone +49 (22 03) 49-5 23 25
Fax +49 (22 03) 49-5 23 36
info.rssys@rohde-schwarz.com

GEDIS GmbH
Sophienblatt 100
D-24114 Kiel

Phone +49 (431) 600 51-0
Fax +49 (431) 600 51-11
sales@gedis-online.de

HAMEG Instruments GmbH
Industriestraße 6
D-63533 Mainhausen

Phone +49 (61 82) 800-0
Fax +49 (61 82) 800-100
info@hameg.de

Locations Worldwide

Please refer to our homepage: www.rohde-schwarz.com

- ◆ Sales Locations
- ◆ Service Locations
- ◆ National Websites

Documentation Overview

The user documentation for the R&S ESL is divided as follows:

- Quick Start Guide
- Online Help
- Operating Manual
- Service Manual
- Internet Site
- Release Notes

Quick Start Guide

This manual is delivered with the instrument in printed form and in PDF format on the CD. It provides the information needed to set up and start working with the instrument. Basic operations and basic measurements are described. Also a brief introduction to remote control is given. The manual includes general information (e.g. Safety Instructions) and the following chapters:

Chapter 1	Front and Rear Panel
Chapter 2	Putting into Operation
Chapter 3	Firmware Update and Installation of Firmware Options
Chapter 4	Basic Operations
Chapter 5	Basic Measurement Examples
Chapter 6	Brief Introduction to Remote Control
Appendix A	Printer Interface
Appendix B	LAN Interface

Online Help

The Online Help is part of the firmware. It provides a quick access to the description of the instrument functions and the remote control commands. For information on other topics refer to the Quick Start Guide, Operating Manual and Service Manual provided in PDF format on CD or in the Internet. For detailed information on how to use the Online Help, refer to the chapter "Basic Operations" in the Quick Start Guide.

Operating Manual

This manual is a supplement to the Quick Start Guide and is available in PDF format on the CD delivered with the instrument. To retain the familiar structure that applies to all operating manuals of Rohde&Schwarz Test & Measurement instruments, the chapters 1 and 3 exist, but only in form of references to the corresponding Quick Start Guide chapters.

In this manual, all instrument functions are described in detail. For additional information on default settings and parameters, refer to the data sheets. The set of measurement examples in the Quick Start Guide is expanded by more advanced measurement examples. In addition to the brief introduction to remote control in the Quick Start Guide, a description of the commands and programming examples is given. Information on maintenance, instrument interfaces and error messages is also provided.

The manual includes the following chapters:

- Chapter 1 Putting into Operation, see **Quick Start Guide**
 chapters 1 and 2
- Chapter 2 Advanced Measurement Examples
- Chapter 3 Manual Operation, see **Quick Start Guide**
 chapter 4
- Chapter 4 Instrument Functions
- Chapter 5 Remote Control - Basics
- Chapter 6 Remote Control - Commands
- Chapter 7 Remote Control - Programming Examples
- Chapter 8 Maintenance
- Chapter 9 Error Messages

This manual is delivered with the instrument on CD only. The printed manual can be ordered from Rohde & Schwarz GmbH & Co. KG.

Service Manual

This manual is available in PDF format on the CD delivered with the instrument. It informs on how to check compliance with rated specifications, on instrument function, repair, troubleshooting and fault elimination. It contains all information required for repairing the R&S ESL by the replacement of modules. The manual includes the following chapters:

- Chapter 1 Performance Test
- Chapter 2 Adjustment
- Chapter 3 Repair
- Chapter 4 Software Update / Installing Options
- Chapter 5 Documents

Internet Site

The Internet site at: [R&S ESL EMI Test Receiver](#) provides the most up to date information on the R&S ESL. The current operating manual at a time is available as printable PDF file in the download area.

Also provided for download are firmware updates including the associated release notes, instrument drivers, current data sheets and application notes.

Release Notes

The release notes describe the installation of the firmware, new and modified functions, eliminated problems, and last minute changes to the documentation. The corresponding firmware version is indicated on the title page of the release notes. The current release notes are provided in the Internet.

Conventions Used in the Documentation

To visualize important information quickly and to recognize information types faster, a few conventions has been introduced. The following character formats are used to emphasize words:

Bold	All names of graphical user interface elements as dialog boxes, softkeys, lists, options, buttons etc.
	All names of user interface elements on the front and rear panel as keys, connectors etc.
Courier	All remote commands (apart from headings, see below)
Capital letters	All key names (front panel or keyboard)

The description of a softkey (Operating Manual and Online Help) always starts with the softkey name, and is followed by explaining text and one or more remote control commands framed by two lines. Each remote command is placed in a single line.

The description of remote control commands (Operating Manual and Online Help) always starts with the command itself, and is followed by explaining text including an example, the characteristics and the mode (standard or only with certain options) framed by two grey lines. The remote commands consist of abbreviations to accelerate the procedure. All parts of the command that have to be entered are in capital letters, the rest is added in small letters to complete the words and transport their meaning.

1 Front and Rear Panel

This chapter describes the front panel and the rear panel of the instrument, including all function keys and connectors.

Front Panel View

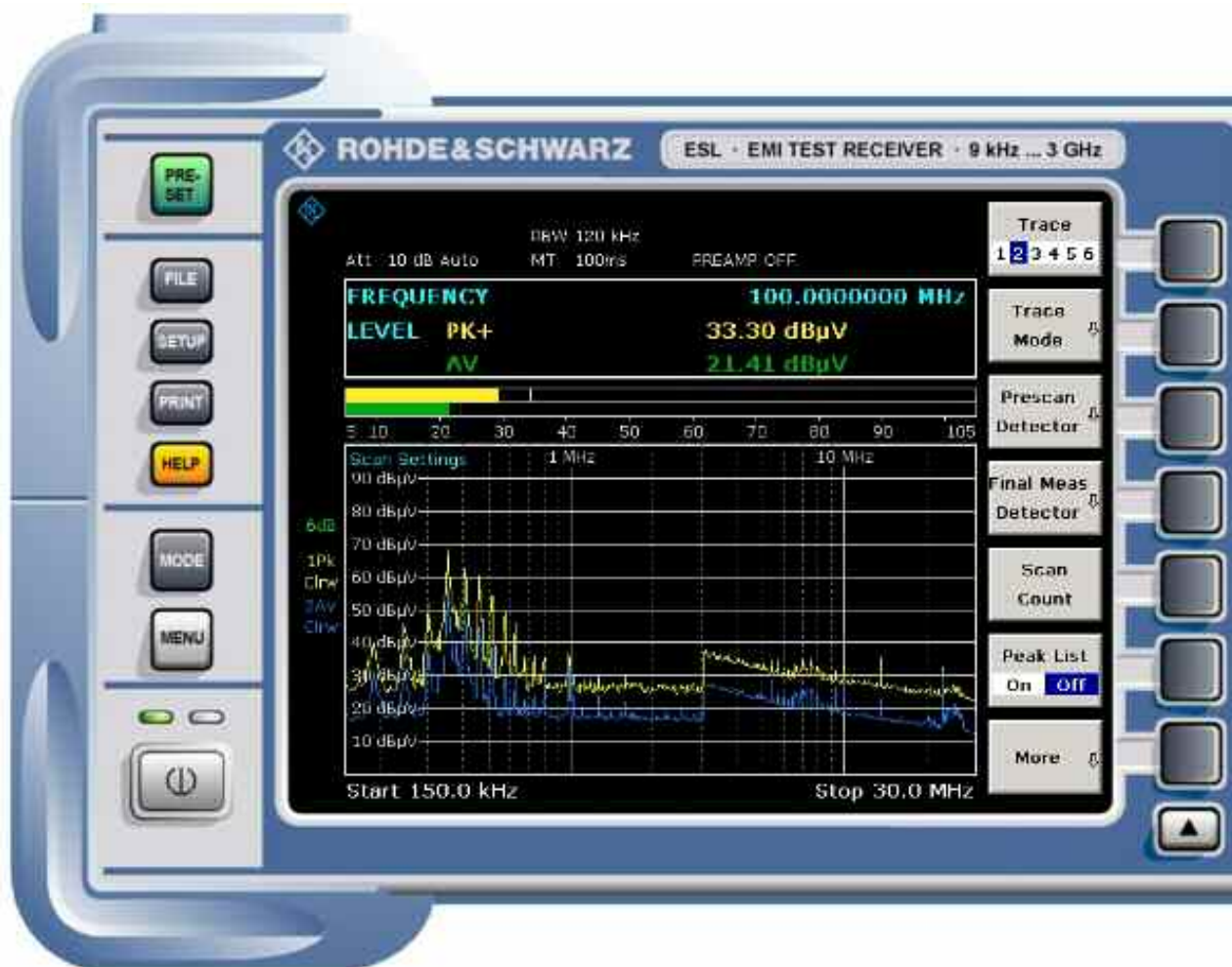



Fig. 1-1 Front panel view



Function Keys on the Front Panel

For details on the ON/STANDBY key refer to chapter 2, section "Power Supply Options". A detailed description of the corresponding menus and the other function keys is provided in the Operating Manual on CD or in the Online Help.

Function key	Assigned functions
ON/STANDBY 	Switches the instrument on and off. For details on the standby mode (only available when the R&S ESL is supplied with AC power) refer to chapter 2, "Preparing for Use", section "Power Supply Options".
PRESET	Resets the instrument to the default state.
FILE	Provides the functions for storing/loading instrument settings and for managing stored files.
SETUP	Provides basic instrument configuration functions: <ul style="list-style-type: none"> • Frequency reference (ext/int), noise source, video/IF output (option Additional Interfaces, R&S FSL–B5), transducer factors • Date, time, display configuration • LAN interface, remote control (option GPIB Interface, R&S FSL–B10) • Self–alignment • Firmware update and enabling of options • Information about instrument configuration incl. firmware version and system error messages • Service support functions (self test etc.) • Transducer factors and LISN control
PRINT	Customizes the printout, selects and configures the printer.
HELP	Displays the Online Help.
MODE	Provides the selection between measurement modes and firmware options.
MENU	Jumps to the highest softkey menu level of the current measurement mode.
FREQ	Sets the center frequency as well as the start and stop frequencies for the frequency range under consideration. This key is also used to set the frequency offset and the signal track function.
SPAN	Sets the frequency span to be analyzed. In receiver mode, it opens the receiver main menu.
AMPT	Sets the reference level, the displayed dynamic range, the RF attenuation and the unit for the level display. Sets the level offset and the input impedance. Activates the autoranging function. Activates the preamplifier (option RF Preamplifier, R&S FSL–B22).
BW	Sets the resolution bandwidth and the video bandwidth.
SWEEP	Sets the stepped scan settings. Sets the sweep time and the number of measurement points. Selects continuous measurement or single measurement.
TRIG	Sets the trigger mode, the trigger threshold, the trigger delay, and the gate configuration in the case of gated sweep (option Gated Sweep, R&S FSL–B8).

Function key	Assigned functions
MKR	<p>Sets and positions the absolute and relative measurement markers (markers and delta markers). In addition, the following measurement functions are assigned under this key:</p> <ul style="list-style-type: none"> • Frequency counter • Noise marker • Phase noise marker • Fixed reference point for relative measurement markers • n dB down function • AF demodulation • Marker list
MKR->	<p>Used for search functions of the measurement markers (maximum/minimum of the trace).</p> <p>Assigns the marker frequency to the center frequency, and the marker level to the reference level.</p> <p>Restricts the search area and characterizes the maximum points and minimum points.</p>
RUN	Starts a new measurement, i.e. a stepped scan in receiver mode.
MEAS	<p>In analyzer mode:</p> <p>Used to perform advanced measurements:</p> <ul style="list-style-type: none"> • Time domain power • Channel, adjacent channel and multicarrier adjacent channel power • Occupied bandwidth • Signal statistics: amplitude probability distribution (APD) and cumulative complementary distribution function (CCDF) • Carrier to noise spacing • AM modulation depth • Third-order intercept point (TOI) • Harmonics <p>In receiver mode:</p> <p>Opens the receiver main menu:</p> <ul style="list-style-type: none"> • Receiver frequency for bargraph measurement • Detector for bargraph measurement • Measurement time for bargraph measurement • Demodulator • Final measurement settings
LINES	Configures display lines and limit lines.
TRACE	Configures the measured data acquisition and the analysis of the measurement data.

Connectors on the Front Panel

All connectors on the front panel are placed on the bottom of the right-hand side. The inscriptions on your instrument are in match with the captions of the connector descriptions below.

Standard Front Panel Connectors

All connectors described in this chapter are provided by the R&S ESL models 03 and 06.

RF INPUT 50 Ω

The RF input is to be connected to the DUT via a cable equipped with a male N connector. It is AC-coupled.

NOTICE **Instrument damage caused by disregarding the following precautions!**

Do not overload the input!

An input DC voltage of 50 V must never be exceeded in order to avoid damage to the instrument. The maximum continuous power at the RF input is 30 dBm (1 W).

PROBE POWER

The R&S ESL provides a connector for supply voltages of +15 V to –12 V and ground for active probes and preamplifiers. A maximum current of 140 mA is available. This connector is suitable as power supply for high-impedance probes from Agilent.

AF OUT

Headphones equipped with a miniature jack plug can be connected to the AF output female connector. To use the AF OUTPUT, in the setup menu (**SETUP** key), select video output. The output voltage (volume) is set via the marker menu or the **MENU** key.

CAUTION **Risk of hearing damage**



Using headphones can result in hearing damage. Check the volume setting carefully before putting on the headphones in order to protect your hearing.

Note: *This connector cannot be used simultaneously to the IF/Video output connector on the rear panel.*

USB

The front panel provides two female USB connectors to connect devices like keyboard (recommended: R&S PSL-Z2, order number 1157.6870.04) and mouse (recommended: R&S PSL-Z10, order number 1157.7060.04). Also a memory stick can be connected to store and reload instrument settings and measurement data. Using an adapter cable (R&S NRP-Z4), a power sensor can be connected, as an alternative to the power sensor connector on the rear panel that is only available with option Additional Interfaces, R&S FSL-B5.

NOTICE **Instrument damage caused by disregarding the following precautions!**

Use suitable double shielded cables. Passive USB connecting cables must not exceed 1 m in length.

Use only USB devices that keep the permissible EMI limits.

Optional Front Panel Connectors

The R&S ESL models 13 and 16 are equipped with a tracking generator and therefore provide a tracking generator output connector.

GEN OUTPUT 50 Ω

The output of the tracking generator is to be connected to the DUT via a cable equipped with a male N connector.

NOTICE **Instrument damage caused by disregarding the following precautions!**

A reverse power of 1 W or 50 V DC must never be exceeded in order to avoid damage to the tracking generator.

Note: *In the case of DUTs with sensitive RF characteristics with regard to matching (VSWR) at the input, insert a 10 dB attenuator between the DUT and the tracking generator.*

Rear Panel View



Fig. 1-2 Rear panel view



Connectors on the Rear Panel

All standard connectors are placed at the bottom of the rear panel. Above all optional connectors are grouped according to their option. The inscriptions on your instrument or in Fig. 1–2 Rear panel view match with the captions of the connector descriptions below, if existing.

Standard Rear Panel Connectors

Unless otherwise stated, all connectors described in this chapter are provided by the standard models R&S ESL Var 03, R&S ESL Var 06, R&S ESL Var 13, R&S ESL Var 16.

AC power supply connector and AC power switch

The AC power supply connector and the AC power switch are located on the rear panel of the instrument. For an overview on available power supplies refer to chapter 2, "Preparing for Use", section "Power Supply Options".

AC power switch function:

Position I Depending on the setting of the ON/STANDBY function key on the front panel, the instrument is either in standby mode or in operation.

Position O The entire instrument is disconnected from the AC power supply.

For details on switching on and off refer to chapter 2, sections "Switching On the Instrument" and "Switching Off the Instrument".

Note: *The AC power switch also interrupts the power supply of the OCXO (option OCXO Reference Frequency, R&S FSL–B4). When switching the instrument back on, be sure to comply with the extended warm–up phase specified in the data sheet.*

LAN

The LAN interface can be used to connect the R&S ESL to a local network for remote control, printouts and data transfer. The assignment of the RJ–45 connector supports twisted–pair category 5 UTP/STP cables in a star configuration (UTP stands for "unshielded twisted pair", and STP for "shielded twisted pair").

EXT TRIGGER / GATE IN

The female connector for external trigger/gate input is used to control the measurement by means of an external signal.

The voltage levels are TTL levels (low <0.7 V; high >1.4 V). The typical input impedance is 10 kΩ.

EXT REF

The setup menu is used to switch between the internal and an external reference. The external reference female connector is used as an input for a 10 MHz reference signal, if **Reference Ext** is selected. The required input level is ≥ 0 dBm.

EXT REF with OCXO option (R&S FSL-B4)

This option generates a very precise 10 MHz reference signal with an output level of ≥ 0 dBm for other devices. The standard connector EXT REF at the rear panel is used as output, but can also be used as input. Whether it is used as input or output is set via the setup menu: with **Reference Ext** as input, with **Reference Int** as output.

Note: *The AC power switch also interrupts the power supply of the OCXO (option OCXO Reference Frequency, R&S FSL-B4). When you switch the instrument back on, be sure to comply with the extended warm-up phase specified in the data sheet.*

MONITOR (DVI-D)

The female DVI-D connector is used to connect an external monitor. Step-by-step instructions how to connect an external monitor are provided in chapter 2, "Preparing for Use".

Note: *The availability of the MONITOR connector depends on the serial number of the instrument.*

Optional Rear Panel Connectors

All connectors described in this chapter are only provided, if the instrument is equipped with the indicated option.

POWER SENSOR (option Additional Interfaces, R&S FSL-B5)

The LEMOSA female connector is used for connecting power sensors of the R&S NRP-Zxy family. Alternatively, the USB port on the front panel can be used for this purpose, if an adapter cable R&S NRP-Z4 is supplied.

NOISE SOURCE CONTROL (option Additional Interfaces, R&S FSL-B5)

The noise source control female connector is used to provide the supply voltage for an external noise source, e.g., to measure the noise figure and gain of amplifiers and frequency converting DUTs.

Conventional noise sources require a voltage of +28 V in order to be switched on and 0 V to be switched off. The output supports a maximum load of 100 mA.
An LED indicates the status: green for +28 V, red for overload and off for 0 V.

IF/VIDEO OUT (option Additional Interfaces, R&S FSL–B5)

The female BNC connector is used as an intermediate frequency (IF) output of approximately 20 MHz or as video output at the set video and resolution bandwidth. The setup menu (**SETUP** key) is used to select between the IF and video output.

Note: This connector cannot be used simultaneously with the AF output connector on the front panel.

AUX PORT (option Additional Interfaces, R&S FSL–B5)

The 9 pole SUB–D male connector provides control signals for controlling external devices. The voltage levels are of the TTL type (max. 5 V).
Pins 2 to 7 control the phases in a LISN.

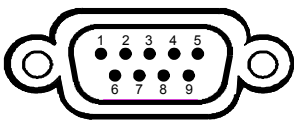

Pin	Signal	Description
1	+5 V / max. 250 mA	Supply voltage for external circuits
2	I/O	Controls Phase N
3	I/O	Controls the 150 kHz highpass filter (ENV216 only)
4	I/O	Controls Phase L3
5	I/O	Not used
6	I/O	Controls Phase L1
7	I/O	Controls Phase L2
8	GND	Ground
9	READY FOR TRIGGER	Signal indicating that the instrument is ready to receive trigger signal.

NOTICE Instrument damage caused by disregarding the following precautions!

Watch the pin assignment carefully. A short-circuit may damage the instrument.

GPIB interface (option R&S FSL–B10)

The GPIB interface is in compliance with IEEE488 and SCPI. A computer for remote control can be connected via this interface. To set up the connection, a shielded cable is recommended. For more details refer to the Operating Manual on CD, chapter "Remote Control – Basics", section "Interfaces and Protocols".

DC power supply (option R&S FSL–B30)

A DC power supply can be connected alternatively to the AC power supply. DC power supplies from +11 to +28 V and from 7 to 2.7 A can be used. The connector is supplied with the accessories and is connected according to the following diagram:

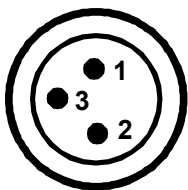

Pin	Description
1	Plus
2	Ground
3	Not used

NOTICE**Instrument damage caused by disregarding the following precautions!**

The used power supply (SELV) must fulfill the requirements for reinforced/double insulation for main supply circuits in accordance to DIN/EN/IEC 61010 (UL 61010B–1, CSA C22.2 No. 1010.1) or DIN/EN/IEC 60950 (UL 1950, CSA C22.2 No. 950). It is recommended to fuse the DC power supply according to the table below. Before switching on the instrument check the connection for correct polarity.

In continuous operation the actual breaking current can differ from the rated breaking current. For fuse selection take the characteristics of the fuse into account.

Input voltage	Max. current or power
11 V to 12.5 V	max. 125 VA
12.5 V to 18.7 V	max. 10 A
18.7 V to 28 V	max. 200 VA

Table 1: Fuse selection

The instrument is switched on or off using the ON/STANDBY function key on the front panel. For details refer to chapter 2, "Preparing for Use", sections "Switching On the Instrument" and "Switching Off the Instrument". For an overview on available power supplies and different modes refer to chapter 2, "Preparing for Use", section "Power Supply Options".

BATTERY PACK (option R&S FSL–B31)

The battery pack can be used alternatively as power supply. If the battery runs low during operation, a message is displayed. In this case, use another power supply or switch off the instrument. For an overview on available power supplies refer to chapter 2, "Preparing for Use", section "Power Supply Options".

The power supply can be changed during operation. To switch from battery to AC or DC power supply, connect the R&S FSL to the AC or DC power supply and, in case of the AC power supply, press the AC power switch on the rear panel to position I.

The instrument is switched on or off using the ON/STANDBY function key on the front panel. For details refer to chapter 2, "Preparing for Use", sections "Switching On the Instrument" and "Switching Off the Instrument". For an overview on available power supplies and different modes refer to chapter 2, "Preparing for Use", section "Power Supply Options".

The battery pack can be reloaded via the AC or DC power supply. For details on charging refer to chapter 2, "Charging the Battery Pack (Option R&S FSL–B31)".

NOTICE Instrument damage caused by disregarding the following precautions!

The used power supply (SELV) must fulfill the requirements for reinforced/double insulation for main supply circuits in accordance to DIN/EN/IEC 61010 (UL 61010B–1, CSA C22.2 No. 1010.1) or DIN/EN/IEC 60950 (UL 1950, CSA C22.2 No. 950). Before switching on the instrument check the connection for correct polarity.

Note: *If the battery is not to be used for a longer time, it is recommended to remove it and store it separately.*

2 Preparing for Use

This chapter describes all procedures to prepare the instrument for use. It starts from putting into operation, proceeds with connecting external devices, configuring the instrument and the LAN interface, and ends with information on the operating system:

- Preparing for Operation
- Connecting External Devices
- R&S ESL Setup
- Configuring the LAN Interface
- Operating System Properties

CAUTION**Risk of injury and instrument damage**

Handling and working with the instrument can cause injury to people or damage to the instrument.

Make sure to follow the instructions in the following sections in order not to endanger people and to avoid damage to the instrument.

This is of particular importance when you use the instrument for the first time. Also read the general safety instructions at the beginning of this manual.

Preparing for Operation

This section describes how to prepare the instrument for operation. It includes the following topics:

- Unpacking the Instrument and its Accessories
- Checking the Accessories
- Ship Damage Inspection
- Warranty
- Recommended Calibration Interval
- Preparing the Instrument for Operation
- Power Supply Options
- Connecting the AC Power
- Switching On the Instrument
- Performing a Self Alignment and a Self Test
- Checking the Furnished Items
- Switching Off the Instrument
- Replacing the Fuses
- Charging the Battery Pack (Option R&S FSL–B31)
- Cleaning the Outside

CAUTION**Risk of injury and instrument damage**

Prior to switching on the instrument, make sure that the following conditions are fulfilled:

- The instrument cover is in place and tightly screwed on.
- Fan openings are not obstructed.
- Signal levels at the inputs are within specified limits.
- Signal outputs are connected correctly and not overloaded.

Any non-compliance may endanger people and may cause damage to the instrument.

Unpacking the Instrument and its Accessories

The instrument is shipped together with its mandatory accessories in a cardboard box. In order to unpack its contents proceed as follows:

1. Remove the instrument from its packaging and check the equipment for completeness using the delivery note and the accessory lists for the various items.
2. First, pull off the polyethylene protection pads from the instrument's rear feet and then carefully remove the pads from the instrument handles at the front.
3. Pull off the corrugated cardboard cover that protects the rear of the instrument.
4. Carefully unthread the corrugated cardboard cover at the front that protects the instrument handles and remove it.
5. Check the instrument for any damage. If there is damage, immediately contact the carrier who delivered the instrument. In this case, make sure not to discard the box and packing material.

It is advisable to keep the original packing material in order to prevent control elements and connectors from being damaged in case the instrument is to be transported or shipped at a later date.

6. In order to move the handle into the desired position, pull at both side knobs and turn the handle.

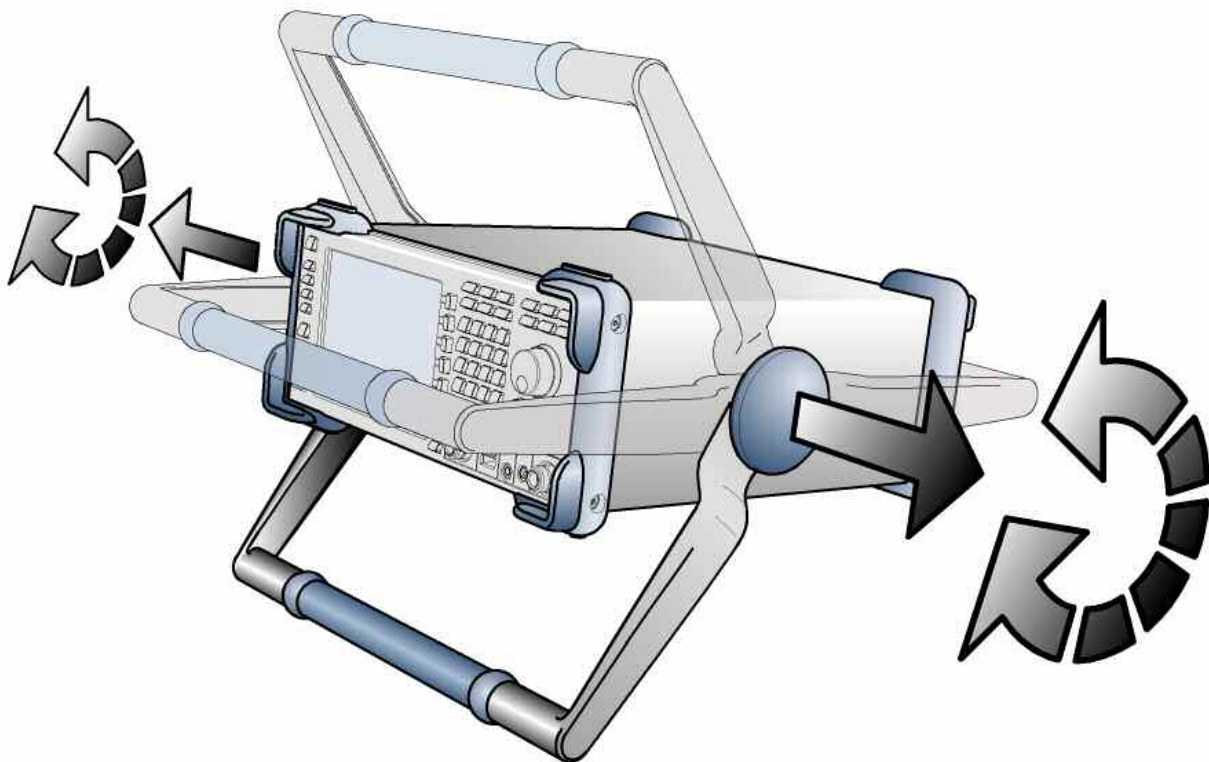

Fig. 2–1 Moving the handle of the instrument

CAUTION**Risk of injury**

Place the instrument on a stable and level surface before moving the handle. Do not place anything on top of the instrument, if the instrument is not in a level position.

Checking the Accessories

The instrument comes with the following accessories:

- Power cable
- Quick Start Guide
- CD "R&S ESL EMI Test Receiver User Documentation"

Ship Damage Inspection

Before inspecting the instrument, check the shipping container and cushioning material for damage. If it is damaged, immediately notify the carrier. Keep the box and packing material until you have verified that the contents are complete and until the R&S ESL has been tested electrically and mechanically.

For further transport or shipment of the R&S ESL, the original packaging should be used. Rohde & Schwarz will only accept claims of warranty if the instrument is shipped with sufficient packaging.

Prior to switching on the instrument check the housing and handle for visible damages or loose parts. If it is damaged, immediately notify the carrier and keep the box and packing material.

Make sure that the fan openings at the sides and on the rear panel of the instrument are not obstructed.

Warranty

For information on warranty conditions for the R&S ESL refer to the terms of the delivery documents.

Recommended Calibration Interval

For information on the recommended calibration interval for the R&S ESL refer to the R&S ESL data sheet.

Preparing the Instrument for Operation

The instrument can be used in standalone operation or can be installed in a rack.

Standalone Operation

The instrument is designed for use under general laboratory conditions.

NOTICE **Risk of instrument damage**

Make sure that the ambient conditions required at the site of operation are met:

- The ambient temperature must be in the range specified in the data sheet.
- All fan openings must be unobstructed and the air flow at the side-panel perforations must be unimpeded. The distance to the wall should be at least 10 cm.

Any non-compliance may cause damage to the instrument.

Note: *To protect DUTs against electrostatic discharge in the event of human contact, use proper protective equipment:*

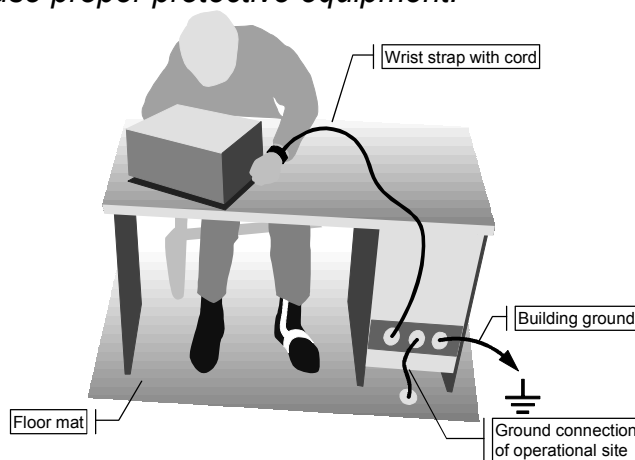

Rackmounting

The instrument may be installed in a 19" rack mount by using a rack adapter kit (Order No. see data sheet). The installation instructions are part of the adapter kit.

NOTICE **Risk of overheating and wrong measurement results**

For rack installation, ensure that the air flow at the side-panel perforations are not obstructed to avoid overheating of the instrument and wrong measurement results.

Power Supply Options

By standard the R&S ESL is equipped with an AC power supply connector. In order to use the R&S ESL independently from an AC power supply, the R&S ESL can be additionally fitted with a DC power supply connector (option DC Power Supply, R&S FSL-B30) or a battery pack (option NiMH Battery Pack, R&S FSL-B31). For details on the connectors refer to chapter 1 "Front and Rear Panel".

From the available power supplies, the R&S ESL selects the one to use according to the following priority scheme:

Priority	Power supply
1	AC power supply
2	DC power supply
3	battery

For example, if the R&S ESL is connected to both an AC and a DC power supply, it uses the AC power supply. If it is suddenly disconnected from the AC power supply, it switches to the DC power supply.

Instrument modes

Three different instrument modes exist:

- On mode
The instrument is supplied with AC power, DC power or battery. After booting, the instrument is ready for operation. A green LED above the ON/STANDBY key indicates this mode.
- Standby mode
This mode is only available if the instrument is connected to the AC power supply (AC power switch in position I; for details refer to chapter 1, "Front and Rear Panel", section "AC power supply connector and AC power switch"). A yellow LED above the ON/STANDBY key indicates this mode. Parts of the instrument are still active, e.g. the oven of the OCXO unit (option OCXO Reference Frequency, R&S FSL-B4) is kept active or the battery (option NiMH Battery Pack, R&S FSL-B31) will be charged. To prevent the instrument from overheating, the fan remains active.
When switched on in this mode, the R&S ESL will rapidly resume operation. It preserves the current settings and when switched back on, the last measurement is displayed.
- Off mode
The instrument is switched off completely. Both LEDs are off. When switched on again, the instrument starts booting. If the OCXO unit (option OCXO Reference Frequency, R&S FSL-B4) is used, an extended warm-up phase as specified in the data sheet is required.

Behavior of the ON/STANDBY key

Depending on the used power supply, the ON/STANDBY key on the front panel leads to different modes. The following table gives an overview. For step-by-step instructions refer to sections "Switching On the Instrument" and "Switching Off the Instrument".

Power supply	Instrument mode	Performed Action	Instrument reaction
AC	on	pressing the ON/STANDBY key	changes into standby or off mode, depending on the status of the Shutdown Off/Standby softkey (SETUP key, for details refer to the Operating Manual)
	on	disconnecting instrument from AC power supply or switching AC power switch in position 0 (not recommended)	changes into off mode without saving the current settings
	standby	pressing the ON/STANDBY key	changes into on mode
	standby	disconnecting instrument from AC power supply or switching AC power switch in position 0	changes into off mode
	off	connecting instrument to AC power supply and/or switching AC power switch at the rear panel in position I	starts booting
DC	on	pressing the ON/STANDBY key	changes into off mode
	off	pressing the ON/STANDBY key	starts booting
	on/off	switching the AC power switch at the rear panel in position I	no action
battery	on	pressing the ON/STANDBY key	changes into off mode
	off	pressing the ON/STANDBY key	starts booting
	on/off	switching the AC power switch at the rear panel in position I	no action

When switched on from standby mode, the R&S ESL will directly display the measurement screen and resume operation after a few moments. Otherwise, after being switched on, the R&S ESL starts booting. It displays the Analyzer BIOS screen and performs a self test of the computer hardware. The firmware starts as soon as Windows XP has resumed operation.

Connecting the AC Power

The R&S ESL can be used with different AC power voltages and adapts itself automatically to it. Refer to the datasheet for the requirements of voltage and frequency. The AC power connector is located on the rear panel of the instrument.



AC power connector

- Connect the R&S ESL to the AC power supply, using the power cable that is supplied.

Since the instrument is assembled in line with the specifications for safety class EN61010, it may only be connected to an outlet that has a ground contact.

Switching On the Instrument

For an overview on available power supplies refer to chapter 2, "Preparing for Use", section "Power Supply Options".

To switch on the instrument

- AC power supply: Press the AC power switch on the rear panel into position I.
- DC power supply/battery or standby mode: Press the ON/STANDBY key on the front panel.

Performing a Self Alignment and a Self Test

Note: *This functional test should only be performed when the operating temperature is reached (approx. 15 minutes after the instrument is switched on, refer to the data sheet for details).*

To perform a self alignment

1. Press the **SETUP** key.
2. Press the **Alignment** softkey
3. Press the **Self Alignment** softkey.
Once the system correction values have been calculated successfully, a message will be displayed.

To perform a self test

1. Press the **SETUP** key.
2. Press the **More** **↓** key.
3. Press the **Service** softkey.
4. Press the **Selftest** softkey.
Once the instrument modules have been checked successfully, a message will be displayed.

Once both steps have been completed successfully, the instrument will be ready for operation.

Note: *The self test does not need to be repeated every time the instrument is switched on. It is only necessary when instrument malfunction is suspected.*

Checking the Furnished Items

The instrument may be equipped with both hardware and firmware options. In order to check whether the installed options correspond to the options indicated on the delivery note, proceed as follows.

To check the installed options

1. Press the **SETUP** key.
2. Press the **More** ↓ key.
3. Press the **System Info** softkey.
4. Press the **Versions + Options** softkey.
A list with hardware and firmware information is displayed.
5. Check the availability of the hardware options: as indicated in the delivery note. The options correspond to the hardware list entries as follows:

Option	Hardware Info Name	Available from Firmware Version
R&S FSL-B4	OCXO	1.82
R&S FSL-B5	Additional Interfaces	1.82
R&S FSL-B10	GPIB Interface	1.82
R&S FSL-B30	DC Power Supply	1.82
R&S FSL-B31	NiMH Battery Pack	1.82

6. Check the availability of the firmware options enabled via license keys as indicated in the delivery note. The following list gives an overview of the options available according to the state of press date. For more recent information refer to the CD.

Option	Option List Name	Available from Firmware Version
R&S FSL-B7*	Narrow IF Filters	1.82
R&S FSL-B8	Gated Sweep	1.82
R&S FSL-B22	RF Preamplifier	1.82
R&S FSL-K7	Analog Demodulation	1.82
R&S FSL-K9	Power Sensor Support	1.82
R&S FSL-K30	Noise Figure Measurements	1.82

* The R&S FSL-B7 is already included in the delivery.

Switching Off the Instrument

Depending on the used power supply, the instrument changes to different modes when pressing the ON/STANDBY key on the front panel or switching off the AC power at the rear panel. An overview is given in section "Power Supply Options".

Note: Do not press the ON/STANDBY key longer than 3 seconds.

To switch to standby mode

Prerequisites:

- The instrument is in operation.
 - The instrument connected to the AC power supply.
 - The AC power switch on the rear panel is in position I.
 - The shutdown behavior is configured accordingly (**SETUP** key; for details refer to the Operating Manual).
- Press the ON/STANDBY key on the front panel.

The R&S ESL will store the current settings on the hard disk and switch to standby mode (for details on the standby mode refer to section "Power Supply Options").

CAUTION

Shock hazard



In standby mode, there is still AC supply voltage present in the instrument.

To change into off mode

- DC power supply/battery:
 - Press the ON/STANDBY key on the front panel.

The R&S ESL changes into off mode.

- AC power supply:

Prerequisite: The shutdown behavior is configured accordingly (**SETUP** key; for details refer to the Operating Manual).

- Press the ON/STANDBY key on the front panel.
- Change the AC power switch on the rear panel to position O, or disconnect the instrument from the AC power supply.

The R&S ESL changes into off mode, if no other power supply (DC or battery) is connected.

Note: The R&S ESL will preserve its current instrument settings if switched off via the ON/STANDBY key. It will lose its settings if switched off at the rear panel or if the power cord is disconnected without pressing the ON/STANDBY key first. In this case, the last settings that were stored on the hard disk will be loaded when you switch the instrument back on.

The AC power switch also interrupts the power supply of the OCXO (option OCXO Reference Frequency, R&S FSL-B4). When you switch the instrument back on, be sure to comply with the extended warm-up phase specified in the data sheet.

Replacing the Fuses

The instrument is protected by two fuses (IEC 127 – T 3.15 H / 250 V) located on the rear panel at the right side of the AC power switch.

CAUTION



Shock hazard

Replacing the fuse while the instrument is switched on and connected to the power supply can cause shock.

Ensure that the instrument is switched off and disconnected from the power supply by removing the plug from the AC and DC power connector to avoid shock.

To replace the fuses

1. Open the lid of the AC power connector.
2. Lift the fuse holder out of its slot.
3. Exchange the two fuses.
4. Put the fuse holder back in its slot and close the lid.

Charging the Battery Pack (Option R&S FSL-B31)

The battery pack can be charged without removing via the AC or the DC power supply:

- To charge the battery using the AC power supply, plug in the AC power supply and switch on the AC power on the rear panel. The ON/STANDBY key on the front panel can be set either way.
- To charge the battery pack using the DC power supply, connect the instrument to the DC power supply.

If you have more than one battery packs in use, you can charge the battery pack outside the instrument using the power supply unit of R&S FSL-Z4 (DC Supply for R&S FSL-B31, stock no. 4052.3041.00).

Charging conditions	Charging duration (approximately)
AC power supply, STANDBY mode	5 h
AC power supply, instrument is switched on	9 h
DC power supply, instrument is switched off	5 h
DC power supply, instrument is switched on	9 h
external charging (battery removed)	5 h

Cleaning the Outside

The outside of the instrument is suitably cleaned using a soft, line-free dust cloth. Make sure that the air vents are not obstructed.

CAUTION

Shock hazard



Cleaning the instrument while it is switched on and connected to the power supply can cause shock.

Before cleaning the instrument, ensure that the instrument is switched off and disconnected from all power supplies: AC power supply, DC power supply, battery pack.

NOTICE

Risk of instrument damage caused by cleaning agents

Cleaning agents contain substances that may damage the instrument, e.g. solvent-containing cleaning agents may damage the front panel labeling or plastic parts.

Never use cleaning agents such as solvents (thinners, acetone, etc), acids, bases, or other substances.

Connecting External Devices

The following interfaces for external devices are provided:

- USB interfaces (refer to section Connecting USB Devices)
- DVI-D connector (refer to section Connecting an External Monitor)

Connecting USB Devices

The two USB interfaces on the front panel of the R&S ESL allow you to connect USB devices directly to the analyzer. This number can be increased as necessary by using USB hubs.

Due to the large number of available USB devices, there is almost no limit to the expansions that are possible with the R&S ESL. The following list shows various USB devices that can be useful for the R&S ESL:

- Power sensors of the NRP Zxy family
- Memory stick for easy transfer of data to/from a computer (e.g. firmware updates)
- CD-ROM drives for easy installation of firmware applications
- Keyboard for entering comments, file names, etc
- Mouse for easy operation of Windows dialog boxes
- Printer for printing out measurement results

Installing USB devices is easy under Windows XP, because all USB devices are plug&play. All USB devices can be connected to or disconnected from the R&S ESL during operation.

After a device is connected to the USB interface of the R&S ESL, Windows XP automatically searches for a suitable device driver.

If Windows XP does not find a suitable driver, it will prompt you to specify a directory that contains the driver software. If the driver software is on a CD, connect a USB CD-ROM drive to the R&S ESL before proceeding.

When a USB device is subsequently disconnected from the R&S ESL, Windows XP immediately detects the change in hardware configuration and deactivates the corresponding driver.

Example: To connect a memory stick to the R&S ESL

1. Connect the memory stick to the USB interface.
Windows XP detects the new hardware and installs the corresponding driver. If installation is successful, Windows XP informs you that the device is ready to use.

The memory stick is made available as a new drive (D:) and is displayed under Windows Explorer. The name of the memory stick is manufacturer-dependent (in this example it is called "Removable Disk"). The memory stick can be used like a normal drive to load or store data.

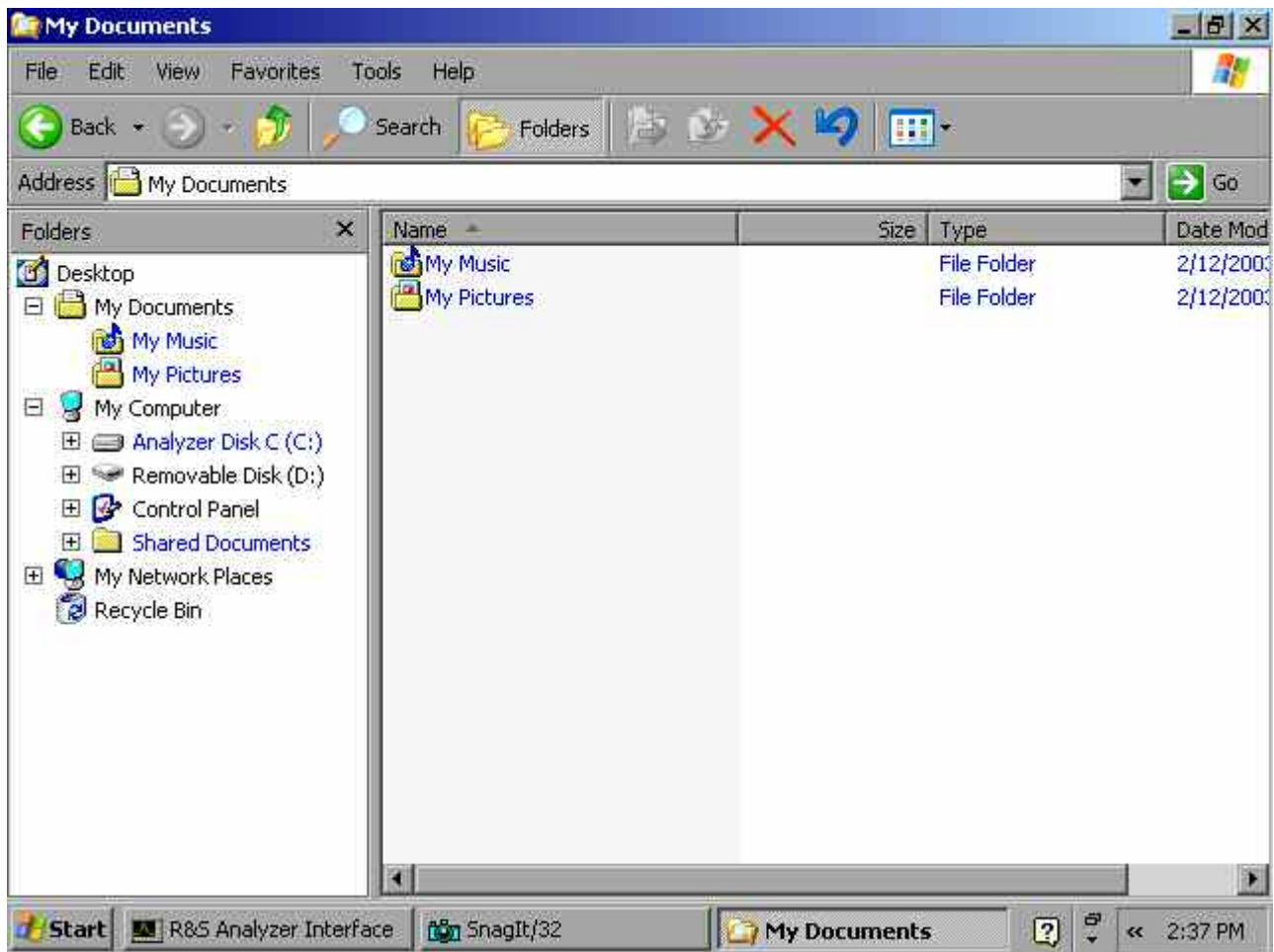

2. If you no longer need the memory stick or if you want to transfer files to another computer, simply disconnect the memory stick.
Windows XP automatically deactivates the driver. If the drive is still selected in Explorer, an error message will appear indicating that the drive is no longer available.

Connecting an External Monitor

You can connect an external monitor at the MONITOR connector on the instrument's rear panel. For details on the connector refer to chapter 1, "Front and Rear Panel".

1. Connect the external monitor to the R&S ESL.
2. Press the **SETUP** key.
The setup menu is displayed.
3. Press the **General Setup** softkey.
4. Press the **More** ↓ key.
5. Press the **Monitor Int/Ext** softkey.
The softkey switches from the internal monitor (**Int**) to the external monitor (**Ext**). The R&S ESL display is disabled (turns dark). The screen content (measurement screen) formerly displayed on the R&S ESL is displayed on the external screen.
6. To display the screen content on the R&S ESL and the external monitor simultaneously, perform the following steps:

- Press the **CTRL+ESC** key combination to display the taskbar.
- On the right side of the taskbar, click the monitor icon.
- Select **Graphics Options - Output To - Intel(R) Dual Display Clone - Monitor + Digital Display**.

The R&S ESL screen and the external screen are both active.

R&S ESL Setup

This section describes how to setup the instrument. It includes the following topics:

- Selecting the Frequency Reference
- Setting the Date and Time
- Configuring the GPIB Interface (Option R&S FSL–B10)
- Setting the Screen Colors
- Setting the Automatic Display Off Function
- Selecting and Configuring Printers

Selecting the Frequency Reference

You can switch the reference signal for frequency processing of the R&S ESL between the internal reference and an external reference signal at 10 MHz as follows:

1. Press the **SETUP** key.
The setup menu is displayed.
2. Press the **Reference Int/Ext** softkey until it is in the desired state.

Note: *If the reference signal is missing when switching to external reference, the message **EXREF** is displayed to indicate that no synchronization is performed. It is important, that the external reference signal is deactivated when switching from external to internal reference to avoid interactions with the internal reference signal.*

→ Remote command: `ROSC:SOUR INT`

Setting the Date and Time

You can set date and time for the internal real time clock as follows:

To open the Date and Time Properties dialog box

1. Press the **SETUP** key.
The setup menu is displayed.
2. Press the **General Setup** softkey.
The general setup submenu is displayed.

3. Press the **Time + Date** softkey to open the **Date and Time Properties** dialog box. The **Date & Time** tab is displayed. You can change hours, minutes and seconds independently of each other.

To change the date

1. Under **Date**, select the month using the rotary knob.
2. Press the **FIELD RIGHT** key to set the focus on the year field and select the year using the rotary knob.
3. Press the **FIELD RIGHT** key to set the focus on the calendar and select the day using the tab keys.

→ Remote command: `SYST:DATE 2004,10,1`

To change the time

1. Press the **FIELD RIGHT** key until the focus is set on the hours of the time field and change the hour setting using the rotary knob.
2. Press the **FIELD RIGHT** key to set the focus on the minutes and change the minute setting using the rotary knob.
3. Press the **FIELD RIGHT** key to set the focus on the seconds and change the second setting using the rotary knob.

→ Remote command: `SYST:TIME 12,30,30`

Configuring the GPIB Interface (Option R&S FSL-B10)

The GPIB interface is offered with option R&S FSL-B10. You can set the GPIB address and the ID response string. The GPIB language is by default set as SCPI and cannot be changed for the R&S ESL.

To display the GPIB submenu

1. Press the **SETUP** key.
The setup menu is displayed.
2. Press the **General Setup** softkey.
The general setup submenu is displayed.
3. Press the **GPIB** softkey.
The submenu for setting the parameters of the remote control interface is displayed.

To set the GPIB address

- In the **GPIB** menu, press the **GPIB Address** softkey.
The edit dialog box for the GPIB address is displayed.

The setting range is from 0 to 30. If SCPI is selected as the GPIB language, the default address is 20.
- ➔ Remote command: `SYST:COMM:GPIB:ADDR 20`

To set the ID response string

- In the **GPIB** menu, press the **ID String Factory** softkey to select the default response to the command `*IDN?`.
- ➔ Remote command: `--`
- In the **GPIB** menu, press the **ID String User** softkey to enter a user-defined response to the command `*IDN?`. The max. length of the output string is 36 characters.
- ➔ Remote command: `--`

Setting the Screen Colors

To change the colors of the displayed objects, two default color settings are provided. Alternatively you can change the color of objects individually using predefined colors or using colors of your own definition. The following step-by-step instructions only describe the process via keys. It is also possible to use the rotary knob as described in chapter 4 "Basic Operations" in principle.

To display the screen colors submenu

1. Press the **SETUP** key.
The setup menu is displayed.
2. Press the **General Setup** softkey.
The general setup submenu is displayed.
3. Press the **Meas Display** softkey.
The meas display submenu is displayed.
4. Press the **Screen Colors** softkey.
The screen colors submenu is displayed.

To use the default color settings

1. In the screen colors submenu (see "To display the screen colors submenu"), press the **Set to Default** softkey to select the default setting for brightness, tint and color saturation of all screen objects.
The **Set User Colors to Default** dialog box is displayed.

2. Select one of the default color sets by using the arrow keys and confirm the selection by pressing the **ENTER** key. The color schemes are selected in such a manner that all screen elements will be optimally visible regardless whether viewed from above or below. In the instrument's default setting, **Default Colors 1** is active.

→ Remote command: `DISP:CMAP:DEF1`

→ Remote command: `DISP:CMAP:DEF2`

To use the predefined color set

1. In the screen colors submenu (see "To display the screen colors submenu"), press the **Select Screen Color Set** softkey.
The **Select Screen Color Set** dialog box is displayed.
2. Select the **User Defined Colors** option by using the arrow keys and confirm the selection by pressing the **ENTER** key.
3. In the screen colors submenu, press the **Select Object** softkey.
The **Color Setup** dialog box is displayed.

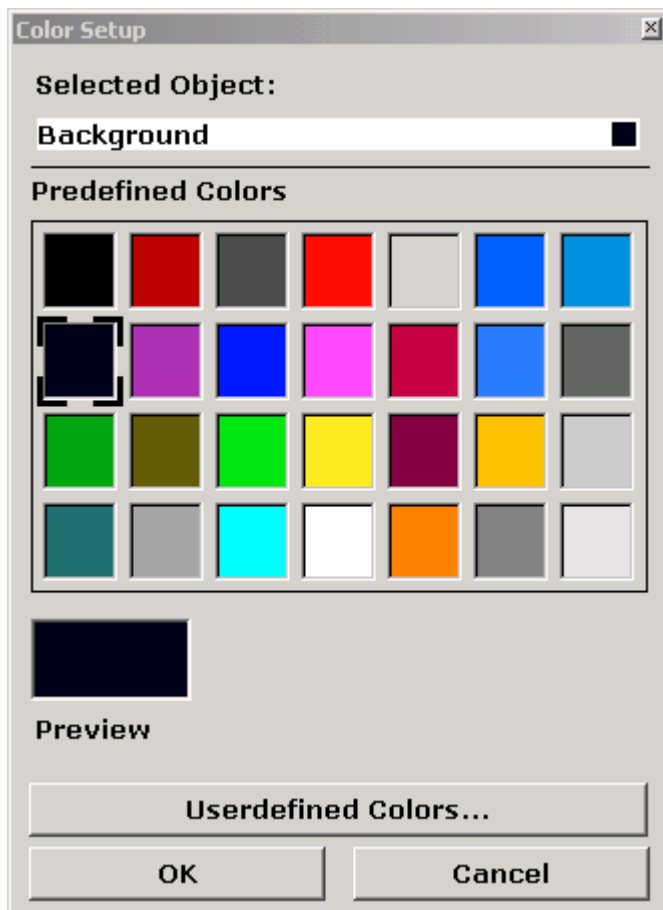

4. In the **Selected Object** list, select the object for which you want to change the color setting by using the arrow keys and confirm the selection by pressing the **ENTER** key.
5. Set the focus on **Predefined Colors** by pressing the **FIELD RIGHT** key.
6. Set the focus on the color you want to select by using the arrow keys and confirm the selection by pressing the **ENTER** key.
The new setting is displayed on the measurement screen.

7. Repeat the steps for all objects that you want to change in color.
8. To change to predefined colors, press the **Userdefined Colors** softkey, or set the focus on the **Userdefined Colors** button by using the **FIELD RIGHT** key and confirm the selection by pressing the **ENTER** key. For details refer to "To define and use your own color set".
9. Focus the **OK** button by using the **FIELD RIGHT** key and confirm by pressing the **ENTER** key to accept the new color settings and to close the dialog box. If you press the **Cancel** button, your changes are discarded.

→ Remote command: `DISP:CMAP1 ... 26:PDEF <color>`

To define and use your own color set

1. In the screen colors submenu (see "To display the screen colors submenu"), press the **Select Screen Color Set** softkey.
The **Select Screen Color Set** dialog box is displayed.
2. Select the **User Defined Colors** option by using the arrow keys and confirm the selection by pressing the **ENTER** key.
3. In the screen colors submenu, press the **Select Object** softkey.
The **Color Setup** dialog box is displayed.
4. In the **Selected Object** list, select the object for which you want to change the color setting by using the arrow keys and confirm the selection by pressing the **ENTER** key.
5. Press the **Userdefined Colors** softkey.

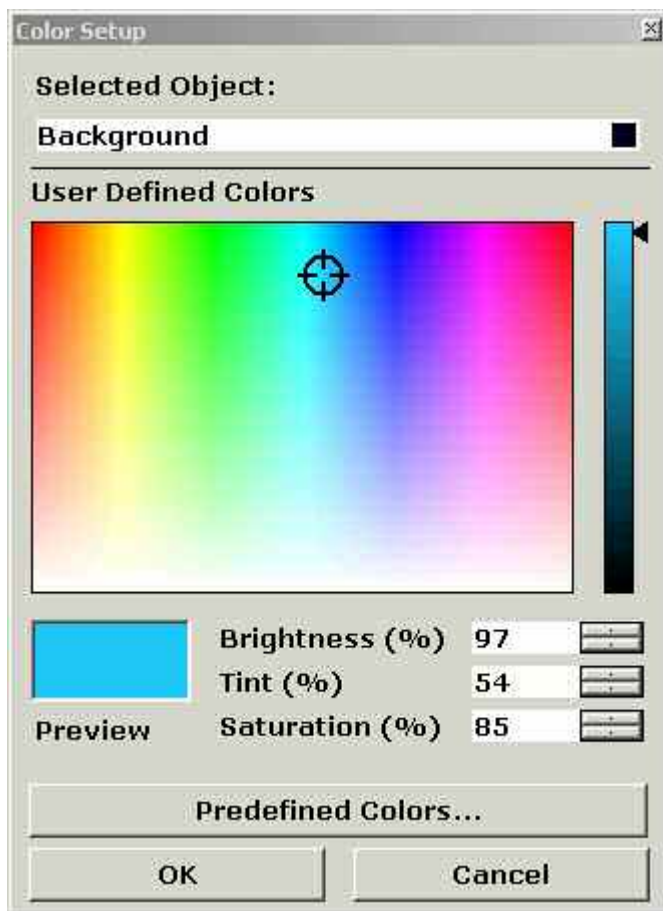

6. Set the focus on **User Defined Colors** by pressing the **FIELD RIGHT** key.
 7. Define the color by setting values for brightness, tint and saturation. Set the focus on the corresponding field by using the **FIELD RIGHT** key, set the value by using the rotary knob and confirm the selection by pressing the rotary knob. In the continuous color spectrum (**Tint**) red is represented by 0% and blue by 100%.
The defined color is displayed in the **Preview** box.
 8. Repeat the steps for all objects you want to change the color.
 9. To change to predefined colors, press the **Predefined Colors** softkey, or set the focus on the **Predefined Colors** button by using the **FIELD RIGHT** key and confirm the selection by pressing the **ENTER** key. For details refer to "To use the predefined color set".
- Remote command: `DISP:CMAP1 ... 26:HSL <hue>,<sat>,<lum>`

Setting the Automatic Display Off Function

The R&S ESL provides a feature for automatically switching off its screen after a user-defined period of time. The background lighting will be disabled if no entries are made from the front panel after the selected response time (key, softkey and rotary knob).

To activate automatic display off

1. Press the **SETUP** key.
The setup menu is displayed.
2. Press the **General Setup** softkey.
The general setup submenu is displayed.
3. Press the **Meas Display** softkey.
The meas display submenu is displayed.
4. Press the **Display Pwr Save On/Off** softkey.
The power save mode is activated (indicated by softkey background color), and the dialog box to enter the response time is displayed.
5. Enter the desired response time in minutes and confirm the entry with the **ENTER** key.
The screen is disabled (turns dark) after the selected period of time.

To deactivate automatic display off

- In the meas display submenu (see above), press the **Display Pwr Save On/Off** softkey twice.
The softkey background color will disappear. The power save mode is switched off.

Selecting and Configuring Printers

You can printout your measurement results using a local printer or a network printer. The analyzer supports two independent printout settings. This allows you to quickly switch between output to a file and a printer.

The procedure for installing a local printer is described in Appendix A. How to install a network printer is described in Appendix B.

To configure the printer and the printout

1. Press the **PRINT** key.
The print menu is displayed.
2. Press the **Device Setup** softkey.
The **Hardcopy Setup** dialog box is displayed.

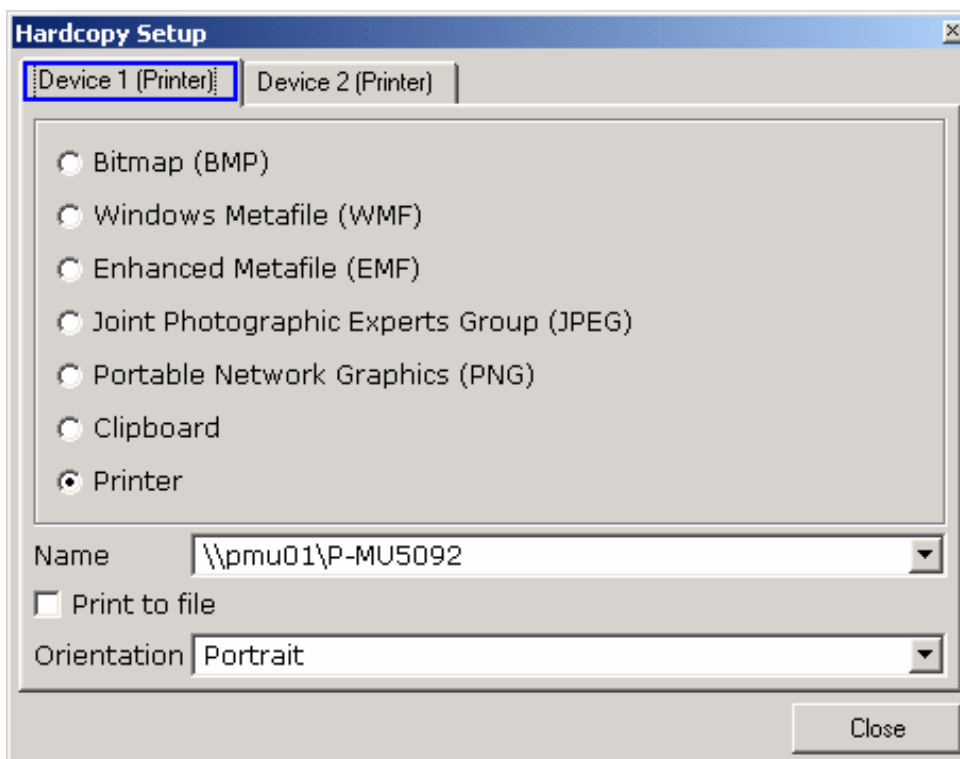

3. If you want to change the tab in order to define the second print setting, press the **Device 1/2** softkey.
4. Define the output via the options. Set the focus on the options area using the **FIELD RIGHT** key and select an option by using the arrow keys:
 - To save the hardcopy in an image file, select one of the image types. Depending on the image type, the color depth varies (e.g. 4-bit for BMP, 24-bit for PNG and JPEG).
 - To copy the image to the clipboard, select the **Clipboard** option.
 - To use a preconfigured network printer, select the **Printer** option.

Note: *The **Name**, **Print to File** and **Orientation** fields are only available if the **Printer** option is selected. You can perform the following steps only with the **Printer** option selected.*

5. Focus the **Name** field by using the **FIELD RIGHT** key and select the desired printer type by using the arrow keys.
6. If you want to redirect the output to a postscript file rather than a printer, focus the **Print to file** option by using the **FIELD RIGHT** key and activate the option by pressing the **CHECKMARK** key.
7. Focus the **Orientation** field by using the **FIELD RIGHT** key and select the desired orientation by using the arrow keys.
8. Close the dialog box by pressing the **ESC** key or by focusing and confirming the **Close** button.

To select the printout colors

1. Press the **PRINT** key.
The print menu is displayed.
2. Press the **Colors** softkey.
The colors submenu is displayed.
3. If you want to print in color, press the **Select Print Color Set** softkey to select the color set.
The **Select Print Color Set** dialog box is displayed.
4. Select the color set by using the arrow keys and confirm your selection by pressing the **ENTER** key.
 - **Screen Colors (Print)** option: The current screen colors are used for the printout. Independently of the current screen colors, the background is printed in white and the grid in black.
Remote command: `HCOP:CMAP:DEF1`
 - **Screen Colors (Hardcopy)** option: The current screen colors without any changes for a hardcopy. For details on the output format see "To configure the printer and the printout".
Remote command: `HCOP:CMAP:DEF4`
 - **Optimized Colors** option: This setting improves the color clarity of the printout. Trace 1 is printed in blue, trace 2 in black, trace 3 in bright green, trace 4 in pink, trace 5 in sea green, trace 6 in dark red, and the markers in sky blue. The background is printed in white and the grid in black. The other colors correspond to the screen colors of the default color setting of the setup menu.
Remote command: `HCOP:CMAP:DEF2`
 - **User Defined Colors** option: You define and use your own color set for the printout. For details how to proceed refer to "Setting the Screen Colors".
Remote command: `HCOP:CMAP:DEF3`
5. If you want a black-and-white printout, press the **Color On/Off** softkey to switch off the color. In the black-and-white printout, all background colors will be printed out in white and all color lines in black. This allows you to improve contrast on the printout.
→ Remote command: `HCOP:DEV:COL ON`

Configuring the LAN Interface

This section describes how to configure the LAN interface. It includes the following topics:

- Connecting the Instrument to the Network
- Configuring the Network Card

For further information on the LAN interface refer to "Appendix B: LAN Interface".

The instrument can be connected to an Ethernet LAN (local area network) using the LAN interface connector on the rear panel (for details refer to chapter 1, "Front and Rear Panel"). This makes it possible to transfer data over the network and to use network printers. In addition, the instrument can be remote-controlled via the network. The network card can be operated with a 10 MHz Ethernet IEEE 802.3 or a 100 MHz Ethernet IEEE 802.3u interface.

Connecting the Instrument to the Network

NOTICE **Risk of network errors!**

Before connecting the instrument to the network, consult your network administrator, particularly in the case of large LAN installations. Connection errors may affect the entire network.

Never connect your analyzer to a network unprotected against virus infection because this may cause damage to the instrument software.

Setting up the connection does not cause any problems on the network. Likewise, disconnecting the instrument from the network does not cause any problems as long as no data traffic to and from the instrument is in progress.

Configuring the Network Card

Under Windows XP, network card drivers do not need to be installed separately. If the instrument is connected to the LAN, Windows XP automatically detects the network connection and activates the required drivers.

Changing the IP address and configuring the network protocols (TCP/IP protocol)

Before starting, check the following:

- Which IP addresses and subnet masks are suitable for your network? If necessary, ask your network administrator.
- Has your network a DHCP server? If necessary, ask your network administrator.
If your network has a DHCP server, the IP address is to be requested from a DHCP server automatically. For the further proceeding refer to "To configure the network protocol in a network with DHCP server".

If your network has no DHCP server, refer to "To configure the network protocol in a network without DHCP server".

To display the network address submenu

1. Press the **SETUP** key.
2. Press the **General Setup** softkey.
3. Press the **Network Address** softkey.
The submenu is displayed.

To configure the network protocol in a network without DHCP server

1. In the network address submenu, set the **DHCP On/Off** softkey to **Off**. If the status is changed from **On** to **Off**, the previous set IP address and subnet mask are retrieved.
2. Press the **IP Address** softkey and enter the IP address, for example *10.0.0.10*. The IP address consists of four number blocks separated by dots. Every block contains 3 numbers in maximum.
3. Press the **Subnet Mask** softkey and enter the subnet mask, for example *255.255.255.0*. The subnet mask consists of four number blocks separated by dots. Every block contains 3 numbers in maximum.
4. If you have entered an invalid IP address or subnet mask, in the status line, the message "out of range" is displayed. The edit dialog box keeps open, and you can start afresh. If the settings are correct, the configuration is saved, and you are prompted to restart the instrument.
5. Confirm the displayed message (**Yes** button) to restart the instrument.

To configure the network protocol in a network with DHCP server

1. In the network address submenu, set the **DHCP On/Off** softkey to **On**.
The IP address of the DHCP server is obtained automatically. The configuration is saved, and you are prompted to restart the instrument.
2. Confirm the displayed message (**Yes** button) to restart the instrument.

Operating System Properties

This section describes the operating system properties. It includes the following topics:

- Windows XP Software Approved for the R&S ESL
- Windows XP Service Packs
- Login
- Windows XP Start Menu

The instrument contains the Windows XP operating system. To ensure that the instrument software functions properly, certain rules must be adhered to when using the operating system.

NOTICE Possible impairment of the instrument functioning

The instrument is equipped with the Windows XP operating system. It is thus possible to install commercial off-the-shelf software on the instrument. The use and installation of commercial off-the-shelf software may impair the instrument function. For this reason, we recommend that you only execute programs tested by Rohde & Schwarz with regard to their compatibility with the instrument software. The tested program packages are listed in section Windows XP Software Approved for the R&S ESL.

In certain cases, the use of these programs can impair the performance of the instrument.

The drivers and programs used on the instrument under Windows XP have been adapted to the instrument. Existing instrument software must only be modified with update software released by Rohde & Schwarz.

Windows XP Software Approved for the R&S ESL

The driver software that is used and the system settings of Windows XP have been fine-tuned to support the measurement functions of the R&S ESL. Thus, for flawless instrument function software and hardware approved or offered by Rohde & Schwarz must be used.

Using other software or hardware may cause the functions of the R&S ESL to perform improperly or fail. The following program packages have been successfully tested for compatibility with the measurement instrument software:

- R&S FS-K3 – Software for measuring noise factor and gain
- R&S FS-K4 – Software for measuring phase noise
- R&S Power Viewer (virtual power meter for displaying results of the R&S NRP power sensors)
- Windows XP Remote Desktop
- FileShredder – For reliable deletion of files on the hard disk
- Symantec Norton AntiVirus 2005 – Virus-protection software
- McAfee Virusscan

Windows XP Service Packs

The Windows XP operating system on the instrument is supplied with pre-installed Windows XP service packs that are necessary and suitable for operating the instrument.

NOTICE **Risk of malfunctions**

To prevent malfunctions that might in the worst case require instrument repair, only service packs approved by Rohde & Schwarz may be installed on the instrument.

You should be particularly careful not to use service packs from Windows XP Home Edition or Professional Edition because they are not compatible with Windows XP.

Login

Windows XP requires that users identify themselves by entering a user name and password in a login window. The instrument provides a factory-installed auto login function, i.e. login is carried out automatically in the background. The ID used for autologin has administrator rights. The username and password by default are both "instrument".

For information on how to deactivate the automatic login, refer to "Appendix B: LAN Interface", section "To deactivate the automatic login mechanism".

Windows XP Start Menu

The Windows XP Start menu provides access to the Windows XP functionality and installed programs. From the start menu, you can navigate to the submenus by using the mouse or the cursor keys of the keyboard.

Note: *The following operations require an external keyboard.*

To open the Windows XP Start menu

- On your keyboard, press the Windows key or the **CTRL+ESC** key combination.

To return to the measurement screen

- Press the **ALT+TAB** key combination to switch to the analyzer application.
- On the task bar, click the **R&S Analyzer Interface** button.

3 Firmware Update and Installation of Firmware Options

This chapter describes how to update the firmware and how to activate optional firmware packages.

Firmware Update

You can install a new firmware version via USB devices (e.g. a memory stick), GPIB (option GPIB Interface, R&S FSL-B10), or LAN. Normally, you install a new version as described in "To update the firmware". If an exception occurs and you cannot proceed according to this description, you can install a new firmware version via the Windows XP Start menu as described in "To update the firmware (via Windows XP)".

To update the firmware

1. Press the **SETUP** key.
The setup menu is displayed.
 2. Press the **More ↓** softkey.
The side menu is displayed.
 3. Press the **Firmware Update** softkey.
The submenu for installing new firmware versions is displayed.
 4. Press the **Firmware Update** softkey.
The **Firmware Update** dialog box with the default update path "D:\FW_UPDATE" is displayed.
 5. If you install from a memory stick or another USB device and the update path is different from the default path, enter the drive name and directory via the keypad.
Example: The installation files are stored on a memory stick in the "Update" directory. After you insert the memory stick, it will be detected as drive "D:". Therefore, the required path specification is "D:\UPDATE".
 6. If you install via LAN using the Remote Desktop application and the update path is different from the default path, enter the drive name and directory or press the **Browse** button to locate the directory:
 - In the displayed dialog box, select the drive.
 - On the selected drive, select the folder that contains the installation files (*.msi).
 - Press the **Select** button to confirm your selection and go back to the **Firmware Update** dialog box.
 7. Focus the **Execute** button using the **FIELD RIGHT** key and press the **ENTER** key to start the installation program.
The installation program will guide you through the installation.
 8. After the firmware update, the **UNCAL** status display indicates the necessity of a self alignment. Perform a self alignment (for details refer to chapter 2, "Performing a Self Alignment and a Self Test").
- Remote command: "SYST:FIRM:UPD 'D:\FW_UPDATE' "

If you cannot proceed according to the above described step-by-step instructions, you can install a new firmware version via the Windows XP Start menu.

To update the firmware (via Windows XP)

This procedure is only recommended, if the procedure described above is not practical.

Note: For the following step-by-step instructions, a mouse or an external keyboard is required.

1. Close all applications.
2. In the Windows XP **Start** menu, select **Programs**, **Accessories**, and then **R&S ESL Update Tool**.
The Windows dialog box to open a file is displayed.
3. Select the R&S ESL.package file.
4. Click the **Open** button.
The **Install Manager** dialog box is displayed. To call help for this dialog box, press F1 or the **HELP** key on the front panel of the R&S ESL.
If desired, you can activate or deactivate firmware options.
5. Click the **Install** button.

Firmware Options

Firmware options are enabled by entering license keys via the following operating sequence.

To activate firmware options

1. Press the **SETUP** key.
The setup menu is displayed.
2. Press the **More** **↓** softkey.
The side menu is displayed.
3. Press the **Option Licenses** softkey.
4. Press the **Install Option** softkey.
An edit dialog box is displayed.
5. Enter the option key number using the keypad.
6. Press the **ENTER** key.
On a successful validation the message **option key valid** is displayed. If the validation failed, the option software is not installed.

4 Basic Operations

This chapter gives an overview how to work with the R&S ESL. It describes what kind of information is displayed in the diagram area, how to operate the R&S ESL via the front panel keys and softkeys, and how to use the Online Help. The conventions used in the documentation are explained at the beginning of this manual.

Information in the Diagram Area

The following figure shows a measurement diagram during analyzer operation. All different information areas are labeled. Some areas display information in short form that is explained in more detail in the following sections:

- Display of Hardware Settings in receiver mode
- Display of Hardware Settings in analyzer mode
- Status Displays
- Trace Information
- Enhancement Labels

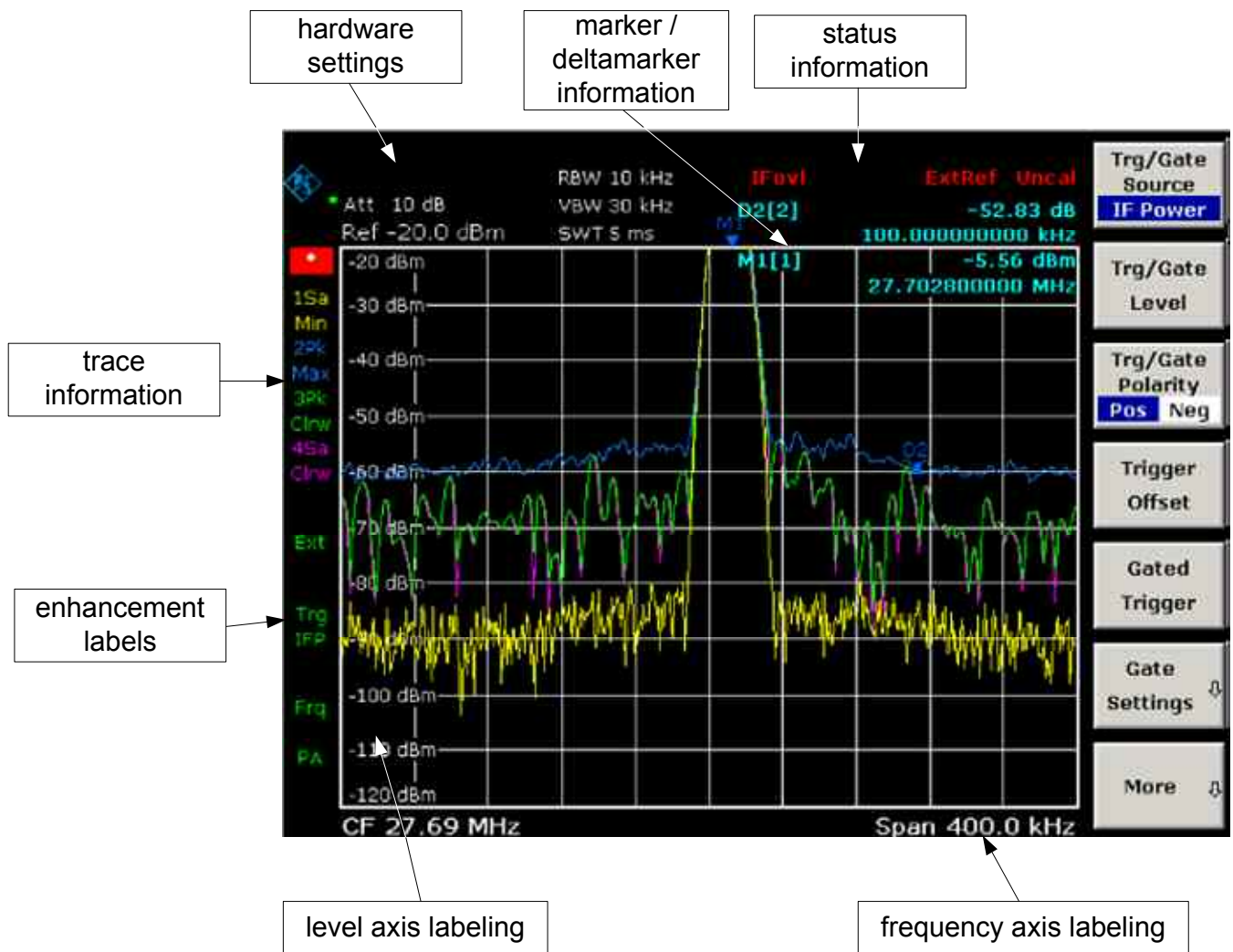

Fig. 4-1 Screen layout of the R&S ESL during analyzer operation

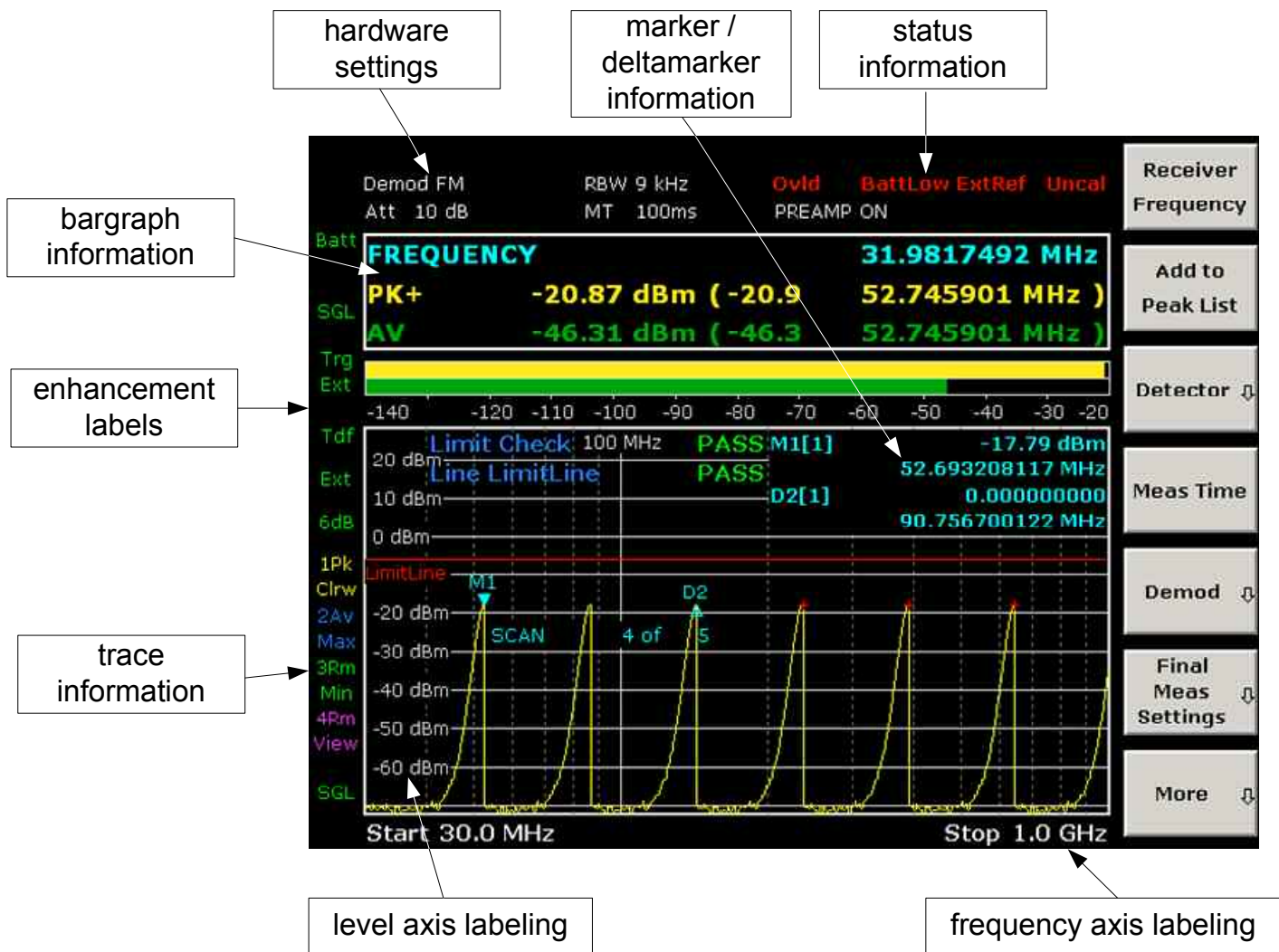

Fig. 4-2 Screen layout of the R&S ESL during receiver operation

Display of Hardware Settings in receiver mode

Demod	Type of demodulation in use. The demodulator is indicated by the following abbreviations: <ul style="list-style-type: none">• AM Amplitude demodulation activated• FM Frequency demodulation activated
Att	RF attenuation that has been set
RBW	Resolution bandwidth that has been set. If the CISPR bandwidth is uncoupled, a green asterisk "*" is displayed in front of the field.
MT	Measurement time that has been set.
PREAMP	Indicates whether the preamplifier is activated or deactivated.
LIMIT CHECK	Results of the limit check
Marker/Delta	The x and y axis positions of the last marker or delta marker that was set as well as its index. The value in the square brackets after the index indicates both the trace to which the marker is assigned and the active measurement function.

Display of Hardware Settings in analyzer mode

Ref	Reference level
Offset	Reference level offset
Att	RF attenuation that has been set.
RBW	Resolution bandwidth that has been set. If the bandwidth does not correspond to the value for automatic coupling, a green asterisk "*" will appear in front of the field.
VBW	Video bandwidth that has been set. If the bandwidth does not correspond to the value for automatic coupling, a green asterisk "*" will be displayed in front of the field.
SWT	Sweep time that has been set. If the sweep time does not correspond to the value for automatic coupling, an asterisk "*" will be displayed in front of the field. The color of the asterisk will turn to red if the sweep time is set below the value for automatic coupling. In this case, the sweep time must be increased.
LIMIT CHECK	Results of the limit check.
Marker / Delta	<p>The x and y axis positions of the last marker or delta marker that was set as well as its index. The value in the square brackets after the index indicates both the trace to which the marker is assigned and the active measurement function.</p> <p>The measurement functions of the markers are indicated with the following abbreviations:</p> <ul style="list-style-type: none">• FXD Reference fixed marker active• PHN Phase noise measurement active• CNT Frequency counter active• TRK Signal track active• NOI Noise measurement active• MOD Measurement of the AM modulation depth active• TOI TOI measurement active

Status Displays

The status displays on the left side of the diagram indicate any irregularities.

UNCAL One of the following conditions is present:

Correction data has been switched off.

⇒ Switch on the correction data.

No correction values are available. This occurs, for example, if a firmware update is performed followed by a cold start of the instrument.

⇒ Record the correction data by performing a self alignment (for details refer to chapter 2, "Performing a Self Alignment and a Self Test").

OVLD Overload of the input mixer.

⇒ Increase the RF attenuation.

IFOVL Overload of the IF signal path after the input mixer.

⇒ Increase the reference level.

LOUNL Error in the instrument's frequency processing hardware was detected.

ExtRef Instrument was set to an external reference but no signal was detected on the reference input.

OVEN OCXO reference frequency (option R&S FSL-B4) has not yet reached its operating temperature. The message usually disappears a few minutes after power has been switched on.

Trace Information

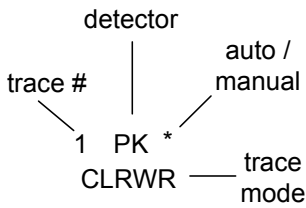

Trace # = trace number (1 to 6)

Detector = selected detector:

- AP** AUTOPEAK detector
- Pk** MAX PEAK detector
- Mi** MIN PEAK detector
- Sa** SAMPLE detector
- Av** AVERAGE detector
- Rm** RMS detector
- QP** QUASIPEAK detector
- CA** CISPR Average
- CR** CISPR RMS

auto / manual = The selected detector does not match the one for automatic coupling.

Trace Mode = display of the sweep mode:

- Clrw** CLEAR/WRITE
- Max** MAX HOLD
- Min** MIN HOLD
- Avg** AVERAGE
- View** VIEW

Enhancement Labels

The enhancement labels on the right-hand side of the measurement diagram indicate that the user chose instrument settings that affect the measurement results even though this is not immediately apparent from the display of the measured values.

* The current instrument setting does not match the one during which the displayed traces were recorded. This occurs in the following cases:

- The instrument setting is changed while a measurement is in progress.
- In the single sweep mode, the instrument setting has been changed after the end of the sweep, and a new sweep is not started.
- The instrument setting has been changed after a trace has been set to view.

The display remains on screen until the user eliminates the cause. In some cases, this involves starting a new sweep (single sweep mode) or changing the mode of the affected trace to **Blank**.

BAT	The power is supplied by battery.
DC	An external DC power supply is in use.
Ext	The instrument is configured for operation with an external reference.
Sgl	The sweep is set to single sweep mode.
Trg	Instrument triggering is not free running.
Vid	The video trigger is activated.
Frq	A frequency offset $\neq 0$ Hz is set.
Tdf	A transducer factor is activated.
PA	The preamplifier is activated.
NCor	Correction data are not used.
GAT	The frequency sweep is controlled via the EXT TRIG / GATE IN connector.
75 Ω	The input impedance of the instrument is set to 75 Ω .
Pwr Max	The power mode Max Hold is activated.

Setting Parameters

This section describes how to operate the R&S ESL. The instrument provides a user interface for operation without external keyboard:

- Keypad
- Rotary Knob
- Softkeys
- Dialog Boxes

All tasks necessary to operate the instrument can be performed using this user interface. Apart from instrument specific keys all other keys that correspond to an external keyboard (e.g. arrow keys, **ENTER** key) operate conform to Microsoft. The following basic tasks are described in this section:

- To enter numeric parameters
- To enter alphanumeric parameters
- To navigate in dialog boxes
- Specialties in Windows dialog boxes

Keypad



The keypad is used to enter alphanumeric parameters. It contains the following keys:

- Alphanumeric keys
Enters numbers and (special) characters in edit dialog boxes. For details refer to "To enter numeric parameters" and "To enter alphanumeric parameters".
- Decimal point
Inserts a decimal point "." at the cursor position.
- Sign key
Changes the sign of a numeric parameter. In the case of an alphanumeric parameter, inserts a "-" at the cursor position.
- Unit keys (GHz/-dBm MHz/dBm, kHz/dB and Hz/dB)
These keys add the selected unit to the entered numeric value and complete the entry.
In the case of level entries (e.g. in dB) or dimensionless values, all units have the value "1" as multiplying factor. Thus, they have the same function as an **ENTER** key. The same is true for an alphanumeric entry.
- **ESC CANCEL** key
Closes all kinds of dialog boxes, if the edit mode is not active. Quits the edit mode, if the edit mode is active. In dialog boxes that contain a **Cancel** button it activates that button.
For edit dialog boxes the following mechanism is used:
 - If the data entry has been started, it will retain the original value .
 - If the data entry has not been started or has been completed, it will close the dialog.

- **ENTER** key
 - Concludes the entry of dimensionless entries. The new value is accepted.
 - With other entries, this key can be used instead of the **Hz / dB.** unit key.
 - In a dialog box, presses the default or focused button.
 - In a dialog box, activates the edit mode for the focused area, if available. For details on the edit mode refer to section "To navigate in dialog boxes".
 - In a dialog box, activates or deactivates the selected option of the focused area, if the edit mode is active.
- **BACK** key
 - If an alphanumeric entry has already been started, this key deletes the character to the left of the cursor.
 - If an entry has been completed or not yet started, this key toggles between the currently and the previously entered value (undo function).

Rotary Knob



The rotary knob has several functions:

- Increments (clockwise direction) or decrements (counter-clockwise direction) the instrument parameter at a defined step width in the case of a numeric entry.
- Moves the focus from one element of the graphical user interface to another like the **FIELD RIGHT** and **FIELD LEFT** keys.
- Shifts the selection bar within focused areas (e.g. lists), if the edit mode is activated.
- Shifts markers, limit lines, etc on the screen.
- Acts like the **ENTER** key, when it is pressed. For details refer to section "Keypad".
- Moves the scroll bar vertically, if the scroll bar is focused and the edit mode is activated.

For details on the edit mode refer to section "To navigate in dialog boxes".

Arrow and Position Keys



Key	Name
	LEFTARROW key
	RIGHTARROW key
	UPARROW key
	DNARROW key
	FIELD LEFT key
	FIELD RIGHT key
	CHECKMARK key
	NEXT TAB key

Table 4–1 Front panel keys for navigation

The **UPARROW** or **DNARROW** keys do the following:

- In a numeric edit dialog box, increase or decrease the instrument parameter.
- In a list, scroll forward and backward through the list entries.
- In a table, move the selection bar vertically.
- In windows or dialog boxes with vertical scroll bar, move the scroll bar.

The **LEFTARROW** or **RIGHTARROW** keys do the following:

- In an alphanumeric edit dialog box, move the cursor.
- In a list, scroll forward and backward through the list entries.
- In a table, move the selection bar horizontally.
- In windows or dialog boxes with horizontal scroll bar, move the scroll bar.

Within a dialog box, the tab keys do the following.

- The **FIELD LEFT** key moves the focus to the previous element of the graphical user interface (e.g. fields, buttons) in edit mode. The corresponding Windows function is BACK TAB.
- The **FIELD RIGHT** key moves the focus to the next element of the graphical user interface in edit mode (e.g. fields, buttons).
- The **NEXT TAB** key opens the next tab of the dialog box.

For details on the edit mode refer to "To navigate in dialog boxes".

The **CHECKMARK** key works as follows in dialog boxes:

- Inserts a blank in an edit dialog box. The corresponding Windows function is SPACE.
- Selects the option on which the focus is set without closing the dialog box. If more than one option can be chosen, it also deselects a selected option.
- Presses the button on which the focus is set.

Softkeys

The softkeys are displayed according to the selected menu. All menus are accessed by the function keys on the front panel (for details on function keys in general see chapter 1, "Front and Rear Panel").

A particular softkey is selected by pressing the corresponding key next to it. The **More** ↓ softkey indicates that the menu contains more softkeys than can be displayed all at once. When pressed, it displays these softkeys. The ▲ key switches to the next higher level of the menu. If the highest level of the menu is reached, the ▲ key switches to the menu of the current measurement mode. The same menu is accessed directly by pressing the **MENU** key on the front panel.

A softkey performs one of the following actions when pressed:

- Opens a dialog box to enter data.
- Switches a function on or off.
- Opens a submenu (only softkeys with a ↓ sign).

In the factory configuration, a softkey is highlighted green when activated. If it is a toggle softkey, the current state is highlighted green. If a dialog box is displayed by pressing a softkey, the corresponding softkey is highlighted red.

If an instrument function is not available temporarily due to a specific setting, the associated softkey is deactivated and its text is grey-colored.

Some softkeys belong to a certain option. If this option is not fitted, the associated softkeys are not displayed.

Dialog Boxes

In most cases, the R&S ESL dialog boxes are designed to enter a numeric value. In the documentation, these dialog boxes are called "edit dialog boxes". Dialog boxes that are not only designed for parameter entry have a more complex structure and, in the documentation, are called "dialog boxes". They are described in section "To navigate in dialog boxes". The navigation in Windows dialog boxes differs in some aspects from the navigation in R&S ESL dialog boxes. For details refer to "Specialties in Windows dialog boxes".

The following figure shows an example of a edit dialog box:

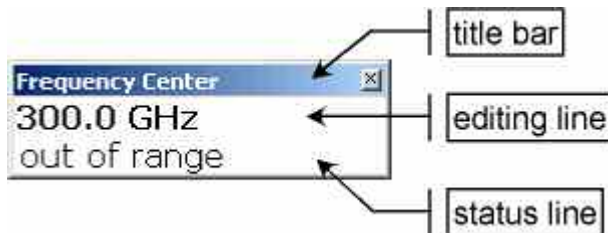

Fig. 4-3 Edit dialog box for parameter entry

The title bar shows the name of the parameter that was selected. The entry is performed in the editing line. When the dialog box is displayed, the focus is on the editing line and it contains the currently used parameter value and its unit. The optional third line shows status and error messages which always refer to the current entry.

To enter numeric parameters

If a field requires numeric input, the keypad provides only numbers.

1. Enter the parameter value using the keypad, or change the currently used parameter value by using the rotary knob (small steps) or the **UPARROW** or **DNARROW** keys (large steps).
2. After entering the numeric value via keypad, press the corresponding unit key. The unit is added to the entry.
3. If the parameter does not require a unit, confirm the entered value by pressing the **ENTER** key or one of the unit keys. The editing line is highlighted in order to confirm the entry.

To enter alphanumeric parameters

If a field requires alphanumeric input, the keypad provides numbers and (special) characters. Every alphanumeric key provides several characters and one number. The decimal point key (.) provides special characters, and the sign key (–) toggles between capital and small letters. For the assignment refer to Table 4–2. In principle, the input of alphanumeric parameters works like writing an SMS on your cell phone.

1. To enter the numbers and (special) characters via the keypad:
 - Press the key once to enter the first possible value.
 - All characters available via this key are displayed in a popup.

- If you want to choose another value provided by this key, press the key again, until your desired value is displayed.
With every key stroke the next possible value of this key is displayed. If all possible values have been displayed, the series starts with the first value again. For information on the series refer to Table 4–2.
 - If you want to change from capital to small letters and vice versa, press the sign key (-).
 - If you have chosen the desired value, wait for 2 seconds (if you want to use the same key again), or start the next entry by pressing another key.
2. To enter a blank, press the **CHECKMARK** key, or press the **0** key and wait 2 seconds.
 3. To correct an entry:
 - Using the arrow keys, move the cursor to the right of the entry you want to delete.
 - Press the **BACK** key.
The entry to the left of the cursor is deleted.
 - Enter your correction.
 4. To complete the entry, press the **ENTER** key or the rotary knob.
 5. To abort the entry, press the **ESC CANCEL** key.
The dialog box is closed without changing the settings.

Key name (upper inscription)	Series of (special) characters and number provided
7	7 μ Ω ° € ¥ \$ ¢
8	A B C 8 Ä Æ Å Ç
9	D E F 9 É
4	G H I 4
5	J K L 5
6	M N O 6 Ñ Ö
1	P Q R S 1
2	T U V 2 Ü
3	W X Y Z 3
0	<blank> 0 - @ + / \ < > = % &
.	. * : _ , ; " ' ? () #
-	<toggles between capital and small letters>

Table 4–2 Keys for alphanumeric parameters

To navigate in dialog boxes

Some of the dialog boxes are not only for parameter entry, and therefore have a more complex structure. The following figure shows an example. The element names that are used in the step-by-step instructions of the Operating Manual and the Online Help are assigned to all dialog box elements.

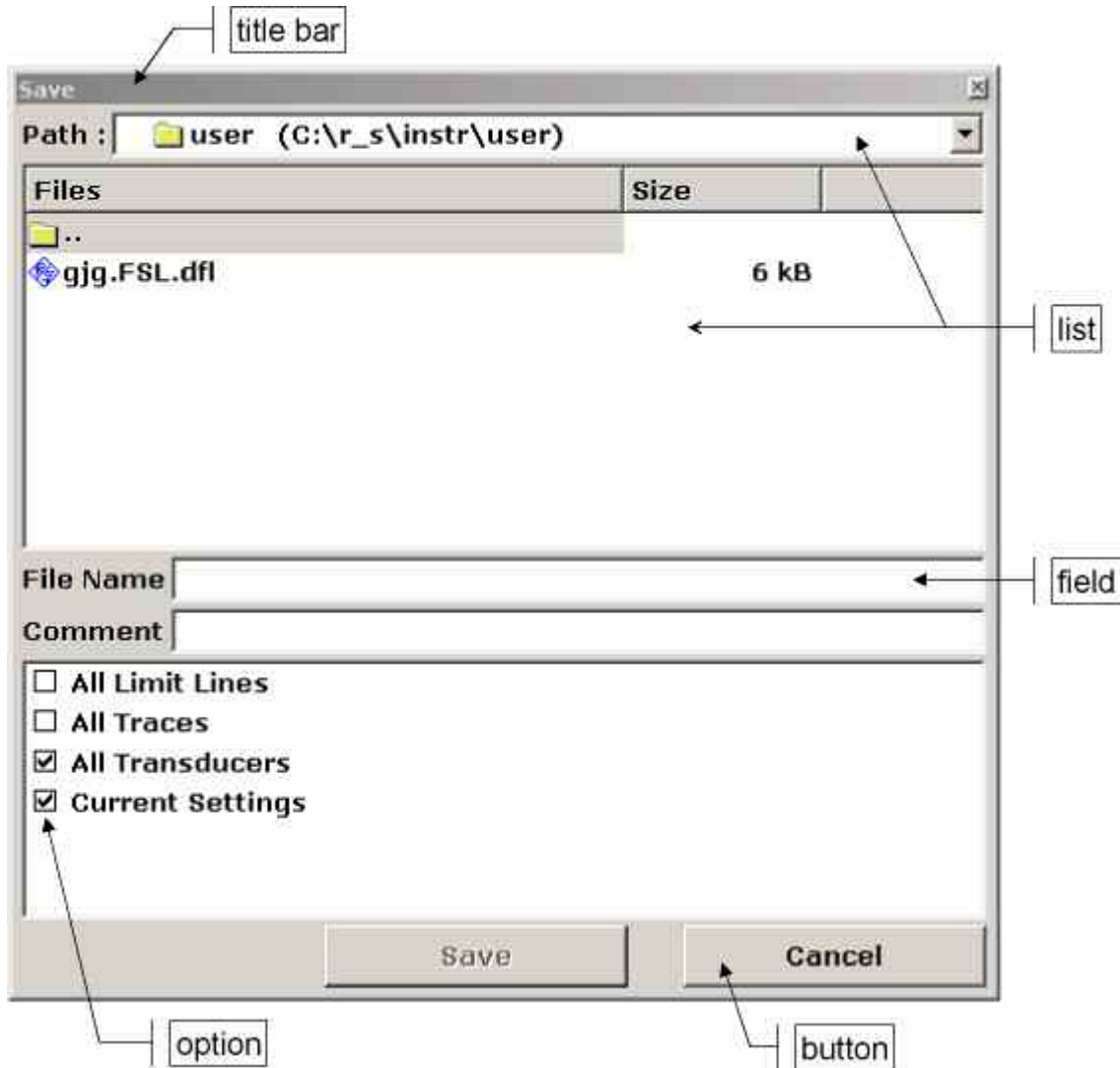

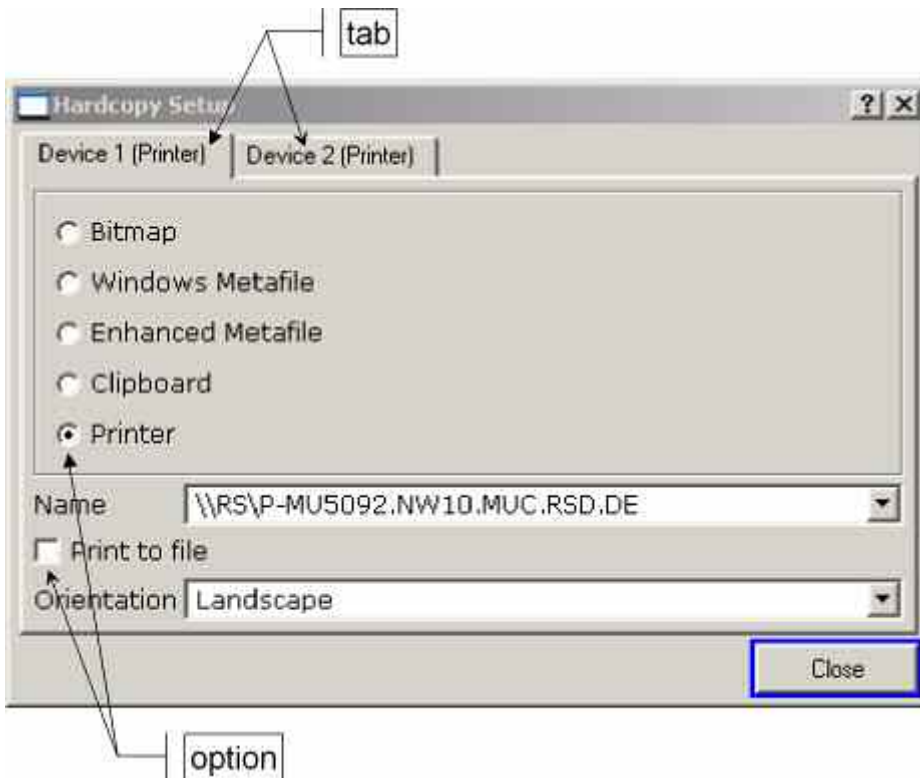

Fig. 4-4 Naming conventions for dialog boxes

The focus on the graphical user interface is moved via the **FIELD LEFT** and **FIELD RIGHT** keys or the rotary knob. The focused area is marked with a blue frame (see Fig. 4-5). If this area consists of more than one elements, e.g. lists of options or tables, it is necessary to enter into the edit mode in order to make changes. A focused area in the edit mode is marked with a dashed blue frame (see Fig. 4-6).

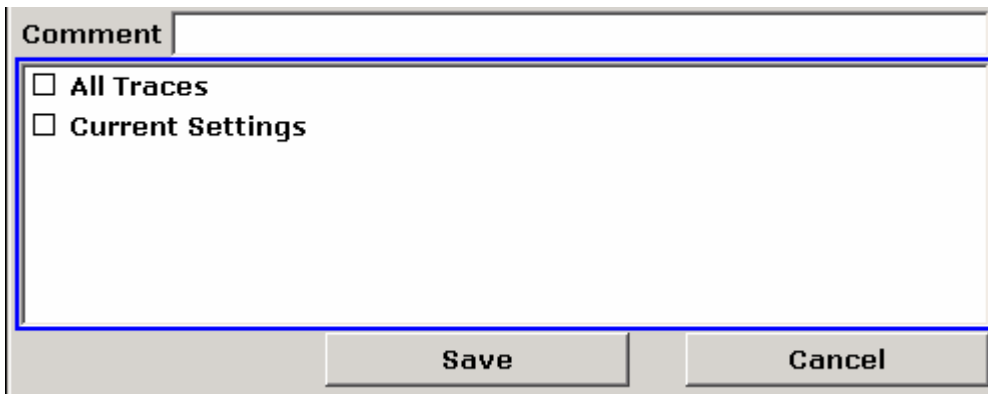

Fig. 4-5 Focused area

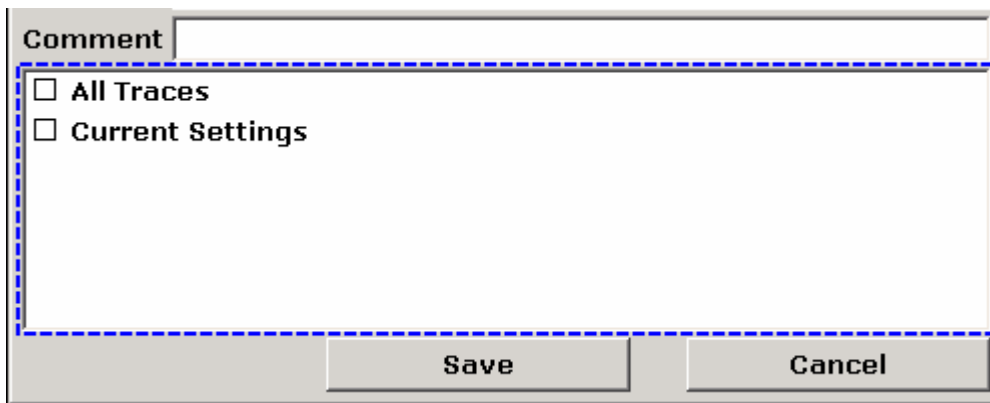

Fig. 4-6 Focused area in edit mode

When using the **FIELD LEFT** and **FIELD RIGHT** keys for focus changes, all focused areas are in the edit mode automatically, if available. When using the rotary knob for focus changes, a manual change into the edit mode (if existent, see above) is necessary. To change into the edit mode, press the rotary knob or the **ENTER** key. To quit the edit mode, press the **ESC** key.

1. To edit alphanumeric parameters, use the keypad. For details see "To enter numeric parameters" and "To enter alphanumeric parameters". If you edit fields, the edit mode is activated automatically when you start typing.
2. To move the focus to the next interface element (e.g. field, option, list), press the **FIELD RIGHT** key, or, if the edit mode is off, turn the rotary knob to the right.
3. To move the focus to the previous interface element, press the **FIELD LEFT** key, or, if the edit mode is off, turn the rotary knob to the left.
4. To select or deselect an option:
 - If the focused area consists of more than one options and the edit mode is not active, change into the edit mode.
 - Scroll through the list of options using the arrow keys or the rotary knob (only for vertical direction) until the option you want to activate or deactivate is highlighted.
 - Press the rotary knob, the **ENTER** key or the **CHECKMARK** key to confirm your choice.
The option is activated or deactivated, depending on its previous setting.
 - To leave the edit mode, press the **ESC** key.
5. To open a drop-down list, press the **ENTER** key or the rotary knob. When opened, the list is in the edit mode.
6. To select an entry without opening a drop-down list, use the arrow keys to browse through the list entries.
7. To select a list entry:
 - If the edit mode is not active, change into the edit mode.
 - Scroll through the list using the arrow keys or the rotary knob until the list entry you want to select is highlighted.
 - Confirm your choice by pressing the rotary knob or the **ENTER** key.
If a drop-down list was opened, it is closed.

8. To change from one tab to the next, press the **NEXT TAB** key or press the rotary knob to enter the edit mode and use the rotary knob.
9. To press a button in a dialog box:
 - Place the focus on the desired button by using the **FIELD RIGHT**, **FIELD LEFT** keys or the rotary knob.
 - Confirm your choice by pressing the rotary knob or the **ENTER** key.
10. To close the dialog box and accept the changes, press the **OK** button.
11. To close the dialog box without accepting the changes, press the **ESC** key or the **Cancel** button.

Specialties in Windows dialog boxes

In some occasions, e.g. if you want to install a printer, you are working in original Windows dialog boxes. In these dialog boxes, the navigation behavior is different to the one you are used from R&S ESL applications. In the following, the important differences and useful tips are listed:

- The rotary knob does not work. Do not use it.
- If you want to activate or deactivate options, use the **CHECKMARK** key and not the **ENTER** key.
- To set the focus on the menu bar, press the **MENU** key. Open the menu via the **ENTER** key and scroll through the commands using the arrow keys.
- To change between the current running Windows programs (under Windows displayed in the task bar), press the **MENU+FIELD RIGHT** key combination.
- To change from tab to tab, press the **NEXT TAB** key as in R&S ESL applications.

How to Use the Help System

For every softkey context-sensitive help is available. In addition, the help system provides a table of contents to access non context-sensitive information.

To call context-sensitive and non context-sensitive help

1. Press the **HELP** key on the front panel to display the help dialog box.
The help dialog box – **View** tab is displayed. A topic containing information about the current menu or the currently opened dialog box and its function is displayed.
The help dialog box contains four tabs: **Contents**, **View**, **Index** and **Zoom**. To change between these tabs, press the **NEXT TAB** key.
2. If the help is already displayed, press the softkey for which you want to display help.
A topic containing information about the softkey and its function is displayed.
3. If a softkey opens a submenu and you press the softkey a second time, the submenu of the softkey is displayed.

To navigate in the table of contents

1. To move through the displayed contents entries, use the **UPARROW** and **DNARROW** keys. Entries that contain further entries are marked with a plus sign.
2. To display contents entries of a lower hierarchy, press the **RIGHTARROW** key.
3. To hide the entries of a lower hierarchy, press the **LEFTARROW** key.
4. To change to the next higher hierarchy level, press the **LEFTARROW** key.
5. To display a help topic, press the **ENTER** key.
The **View** tab with the corresponding help topic is displayed.
6. To change to the next tab, press the **NEXT TAB** key.

To navigate in the help topics (with front panel keys)

1. To scroll through a page, use the rotary knob or press the arrow key.
2. To move from one link to the next, press the **FIELD RIGHT** key.
3. To move from one link to the previous, press the **FIELD LEFT** key.
4. To jump to the linked topic, press the **ENTER** key.
5. To jump to the previous topic, press the **BACK** key.

To search for a topic

1. Change to the **Index** tab using the **NEXT TAB** key.
2. Enter the first characters of the topic you are interested in.
The entries starting with these characters are displayed.
3. Change the focus by pressing the **FIELD RIGHT** key.

4. Select the suitable keyword by using the **UPARROW** or **DNARROW** keys or the rotary knob.
5. Press the **ENTER** key to display the help topic.
The **View** tab with the corresponding help topic is displayed.

To change the zoom

1. Change to the **Zoom** tab using the **NEXT TAB** key.
2. Set the zoom using the rotary knob. Four settings are available: 1–4. The smallest size is selected by number 1, the largest size is selected by number 4.

To close the help window

- Press the **ESC** key or a hardkey on the front panel.

5 Basic Measurement Examples

The measurement examples provided in this chapter are intended as an introduction to operating the R&S ESL. For advanced applications, refer to chapter 1 of the operating manual on CD. The following topics are included:

- Level and Frequency Measurement
- High-Sensitivity Harmonics Measurements
- Separating Signals by Selecting an Appropriate Resolution Bandwidth
- Intermodulation Measurements
- Measuring Signals in the Vicinity of Noise
- Measuring Noise Power Density
- Measurement of Noise Power within a Transmission Channel
- Measuring Phase Noise
- Measuring Channel Power and Adjacent Channel Power

For a more detailed description of the basic operating steps, e.g. selecting menus and setting parameters, refer to chapter 4, "Basic Operations".

Performing a Level and Frequency Measurement

Introduction

This section describes a typical and simple measurement task for an EMI test receiver. Each operating step is explained with the help of an R&S ESL for rapid familiarization of the user without the need to know all the details of the operating functions.

In the introductory example a standard measurement of level and frequency is performed with the aid of the Scan Table. This measurement is an overview and pre-certification measurement to be performed before the final standard-conformal measurement is carried out.

Note: *If unknown (RFI) signals are to be measured, it is strongly recommended to provide for at least 10 dB RF attenuation or a pulse-limiter at the RF input in order to protect the input.*

In the following example, the R&S ESL is set to default values in the receiver mode. The default setup is activated by pressing the PRESET key. The main default parameters in receiver mode are listed in the following table:

Parameter	Setting
Receiver Frequency	100 MHz
RF Attenuation	Auto
Preamplifier	Off
Detector	AV
Measurement Time	100 ms
RES Bandwidth	120 kHz
Demodulation	Off
Trigger	Free Run

Measurement

Measurement and display of RFI signal levels versus frequency is one of the most frequent tasks performed by an EMI Test Receiver. In the case of unknown signals, preset values will mostly be used for the measurement. If levels higher than +137 dB μ V (10 dB RF attenuation) are expected or possible, a power attenuator has to be connected in front of the EMI Test Receiver input. Very high levels may otherwise damage or destroy the attenuator or input mixer.

Main Test Receiver Functions

The main functions required for the level and frequency measurement are setting the Scan Table (Start Frequency, Stop Frequency, Stepsize), selecting the resolution bandwidth (RES BW), setting the measurement time (Meas Time) and selecting the detectors (e.g. peak or average) and Marker functions required for the analysis.

Measurement Sequence – Level Measurement

In this example, the spectrum of the signal present at the RF INPUT is recorded in the frequency range 150 kHz to 30 MHz. The Scan Table and associated parameters are manually set. The example is generally suitable for all fast pre-compliance measurements required for measuring unknown noise spectra of DUTs in the development stage and for modifying prototypes and can be used as a basis for final tests later on.

The high speed of fully synthesized scans, the frequency and amplitude accuracy and the wide dynamic range of the R&S ESL EMI Test Receiver are of utmost importance and very useful for these measurements.

Procedure

1. Set the receiver to its default state.

- Press the **PRESET** key.

2. Program a Scan Table

- Press the **SWEEP** key.
- Press the **Edit Scan Table** softkey.

The Edit Scan Table dialog box opens. Define the whole display range and the subranges in the dialog box.

After the preset scan ranges from 150 kHz to 1 GHz are set on the frequency axis.

- Select a field in the second (Range 2) column and press the Delete Range softkey

All entries in the Range 2 column are cleared

After editing the scan subrange, the frequency display has to be adapted to the new settings. The lowest start frequency of the range 1 scan and the highest stop frequency of the subsequently defined subranges are used for defining the start and stop frequencies of the graphics display. In the example, the limit frequencies of the first scan range are therefore also the limits of the graphics display.

- Press the **Adjust Axis** softkey

The respective frequency values in the table are transferred to adapt the display.

3. Select the detectors

Up to six detectors can be connected in parallel to simultaneously display the amplitude at every frequency as a function of detector weighting. When a parallel detector is selected, the slowest detector (in the sense of a calibrated measurement) determines the speed or the total measurement time required for the scan.

In the example, the peak detector (trace 1) and the average detector (trace 2; default) are used in an overview measurement.

- Press the **TRACE** key.

The peak detector is already assigned to trace 1.

- Press the **Trace** softkey until the blue marker is set to trace 2.
- Press the Trace Mode softkey and select Clear Write by pressing the corresponding softkey.
- Press the **UP** softkey to return to the previous menu.

- Press the **Prescan Detector** softkey and select the Average detector by pressing the corresponding softkey.

The average detector is assigned to trace 2.

4. Start the scan.

- Press the **RUN** key.

The measurement starts and the **Hold Scan** and **Stop Scan** softkeys are displayed. The measurement with the selected Peak and Average detectors is continuously repeated because the default setting Continuous Scan remains unchanged.

- Press the **Stop Scan** softkey when the prescan is finished.

The measurement is aborted.

Peak and average results should be further analyzed with the aid of the built-in marker functions.

Depending on the DUT, diverse trace forms are obtained. For this reason the diagram below should be regarded as an example.

The scaling of the y-axis can be adjusted in the amplitude menu by means of the **Grid Level** softkeys.

5. Analyze the level in frequency domain using the marker functions.

Alternatively, you can use the peak search functions (see step 6)

- Press the **MKR** key.

The marker jumps to the largest signal peak shown on the display screen.

Note: *When the marker is switched on for the first time, it automatically performs the Peak Search function as demonstrated in this example.*

*If a marker was already active, the **Peak** softkey in the MKR-> menu must be pressed in order to set the currently active marker to the displayed signal maximum*

The level and frequency measured by the marker can be read in the marker field at the upper edge of the display screen.

- Move the marker on the trace with the aid of the rotary knob.

The respective level and frequency values are displayed in the marker field.

6. Analyze the level in frequency domain using the peak search functions.

Alternatively, you can use the marker functions (see step 5).

- Press the **MKR->** key.

The marker to menu is displayed.

- Press the **Peak** softkey.

The marker is positioned at the maximum level in the display.

- Press the **Next Peak** softkey.

The marker moves to the next lower level in the spectrum irrespective of whether the frequency is higher or lower than that of the previously measured Peak value.

The displayed spectrum can be further analyzed with the aid of up to 4 markers. The markers can be assigned to different traces.

7. Tune the receiver frequency and obtain final test results by using the quasipeak detector.

The currently measured frequency can be rapidly changed e.g. with the **Tune To Marker** softkey in the marker to menu. Other or additional detectors can be switched on at this receiver frequency and an overview of levels of all active detectors is given. For measurements to standard, the measurement time must first be set to the value laid down in the standard, e.g. 1 s.

- Press the **MKR** key.

Marker 1 is displayed.

Frequency and level values can be read in the marker field at the top left of the screen.

- Press the **MKR->** key.

The marker to menu is displayed.

- Press the **Tune To Marker** softkey.

The current receiver frequency is tuned to the marker frequency.

A measurement time of 1 s is set in this example.

- Press the **MENU** key.

The receiver root menu menu is displayed.

- Press the **Meas Time** softkey.

The window with the currently set measurement time is displayed.

Enter 1 on the numeric keypad and terminate by pressing s.

The new measurement time is displayed.

The quasi peak detector should now be switched on in addition.

- Press the **Detector** softkey.

The detector menu is displayed. The average detector from PRESET is still active.

- Press the **Quasipeak** and the **Max Peak** softkeys.

The level at the current receiver frequency is displayed for three detectors numerically and on three bargraphs.

8. From overview to standard conformal measurement.

- Data reduction and automatic routines for final measurement.

The R&S ESL offers several data reduction methods for interactive or automatic final measurements. For details refer to the Operating Manual, chapter 4.

- Limit lines

A final measurement to standard can be performed when active limit lines are displayed in the diagram during the described analysis and measurements are repeated at all critical frequencies using the standard measurement time and a corresponding detector. For details refer to the Operating Manual, chapter 4.

- Transducer

Care should be taken that the correction values or transducer factors available in tabular form are considered in the measurement result when accessories with frequency-dependent characteristics are used. Several correction tables can be combined to form a transducer set. For details refer to the Operating Manual, chapter 4.

9. Store the test results, tables or diagrams.

In the example, test results are stored on a memory stick. Measured data are output in WMF format for use in other applications.

- Press the **PRINT** key.

The print menu is displayed where the output of measurement and device data can be configured and started.

- Connect a memory stick to the USB port.
- Press the **HCOPY** key again if an explorer window with the contents of the memory stick appears on the screen.
- Press the **Device Setup** softkey and select Windows Metafile (WMF)
- Press the **Print Screen** softkey.

A window is opened to enter file name and path.

- Enter file name and path using the built-in auxiliary line editor or the external keyboard, e.g. *F:\display.wmf* and confirm the entry with the **ENTER** key.

The screen content is stored on the stick under the specified file name.

During storing the softkeys are blanked. Operation in the menus can be continued when the softkeys are displayed again.

The file can be used in other Windows applications, i.e. it can be linked.

Note: *A detailed description of the file management for complete EMI Test Receiver setups, data records for traces (traces 1-3), limit lines and transducer is given in the Operating Manual, chapter 4, section "Operating Concept of File Managers".*

Measuring a Sinusoidal Signal

One of the most common measurement tasks that can be handled by using a spectrum analyzer is determining the level and frequency of a signal. When measuring an unknown signal, you can usually start with the preset setting.

Note: *If levels higher than +30 dBm (=1 W) are expected or are possible, a power attenuator must be inserted before the RF input of the analyzer. If this is not done, signal levels exceeding 30 dBm can damage the RF attenuator or the input mixer. The total power of all signals that are present must be taken into account.*

In the following examples, a signal generator is used as a signal source.

Test setup:

- Connect the RF output of the signal generator to the RF input of R&S ESL.

Signal generator settings (e.g. R&S SMU):

Frequency: 128 MHz
Level: -30 dBm

Measuring the Level and Frequency Using Markers

The level and frequency of a sinusoidal signal can be measured easily by using the marker function. The R&S ESL always displays its amplitude and frequency at the marker position. The frequency measurement uncertainty is determined by the frequency reference of the R&S ESL, the resolution of the marker frequency display and the resolution of the screen.

Procedure:

10. Reset the instrument.
 - Press the **PRESET** key.
11. Connect the signal to be measured to the RF INPUT analyzer input on the instrument front panel.
12. Set the center frequency to 128 MHz.
 - Press the **FREQ** key.
The dialog box for the center frequency is displayed.
 - In the dialog box, enter *128* using the numeric keypad and confirm the entry with the **MHz** key.
13. Reduce the frequency span to 1 MHz.
 - Press the **SPAN** key.
 - In the dialog box, enter *1* using the numeric keypad and confirm the entry with the **MHz** key.

Note: *When the frequency span is defined, the resolution bandwidth, the video bandwidth and the sweep time are automatically reset, because these functions are defined as coupled functions in the preset setting.*

14. Measure the level and frequency using the marker and read the results from the screen.

- Press the **MKR** key.

The marker is activated and automatically set on the maximum of the trace.

Note: *When a marker is initially activated, it automatically performs the peak search function (as shown in the example).*

*If a marker was already active, you have to press the **Peak** softkey in the marker→ menu in order to set the currently active marker to the maximum of the displayed signal.*

The level and frequency values measured by the marker are displayed in the marker field at the top edge of the screen. They can be taken as the measurement result.

```
M1[1]          -30.00 dBm
128.000000000 MHz
```

The field header indicates the number of the marker (Marker 1) and the trace on which the marker is located ([1] = Trace 1).

Increasing the Frequency Resolution

The frequency resolution of the marker is predefined by the pixel resolution of the trace. A trace uses 501 pixels, i.e. when the frequency span is 1 MHz, each pixel corresponds to a span of approx. 2 kHz. This corresponds to a maximum uncertainty of +/- 1 kHz.

You can increase the pixel resolution of the trace by reducing the frequency span.

- Reduce the frequency span to 10 kHz.

- Press the **SPAN** key.
- Using the numeric keypad, enter *10* in the dialog box and confirm the entry with the **kHz** key.

The generator signal is measured using a span of 10 kHz. The pixel resolution of the trace is now approx. 20 Hz (10 kHz span / 501 pixels) , i.e. the precision of the marker frequency display increases to approx. ±10 Hz.

Setting the Reference Level

With spectrum analyzers, the reference level is the level at the upper limit of the diagram. To achieve the widest dynamic range possible for a spectrum measurement, use the entire level span of the spectrum analyzer. In other words, the highest level that occurs in the signal should be located at the top edge of the diagram (=reference level) or immediately below it.

Note: *If the reference level that is selected is less than the highest signal that occurs in the spectrum, the signal path in the R&S ESL will be overloaded. In this case, the message **IFOVL** is displayed on the left-hand edge of the diagram.*

In the preset setting, the value of the reference level is -20 dBm. If the input signal is -30 dBm, the reference level can be reduced by 10 dB without causing the signal path to be overloaded.

1. Reduce the reference level by 10 dB.

- Press the **AMPT** key.

The amplitude menu is displayed in the softkey bar. The **Ref Level** softkey is highlighted in red to indicate that it is activated for data entry. The dialog box for the reference level is also opened and displays a value of -20 dBm.

- Using the numeric keypad, enter 30 and confirm the entry with the **-dBm** key.

The reference level is set to -30 dBm. The maximum of the trace is near the maximum of the measurement diagram. However, the increase in the displayed noise is not substantial. Thus, the distance between the signal maximum and the noise display (=dynamic range) has increased.

2. Setting the marker level equal to the reference level

The marker can also be used to shift the maximum value of the trace directly to the top edge of the diagram. If the marker is located at the maximum level of the trace (as in this example), the reference level can be moved to the marker level as follows:

- Press the **MKR →** key.
- Press the **Peak** softkey.
- Press the **Ref Lvl=Mkr Lvl** softkey.

The reference level is set equal to the measured level where the marker is located.

Thus, setting the reference level is reduced to two keystrokes.

Measuring the Signal Frequency Using the Frequency Counter

The built-in frequency counter makes it possible to measure the frequency more accurately than measuring it with the marker. The frequency sweep is stopped at the marker, and the R&S ESL measures the frequency of the signal at the marker position.

In the following example, the frequency of the generator at 128 MHz is shown by using the marker.

1. Set the spectrum analyzer to the default state.
 - Press the **PRESET** key.
The R&S ESL is set to its default state.
2. Set the center frequency and the span.
 - Press the **FREQ** key and enter *128 MHz*.
The center frequency of the R&S ESL is set to 128 MHz.
 - Press the **SPAN** key and enter *1 MHz*.
The frequency span of the R&S ESL is set to 1 MHz.
3. Activate the marker
 - Press the **MKR** key.
The marker is activated and set to the signal maximum. The level and the frequency of the marker are displayed in the marker field.
4. Activate the frequency counter.
 - In the marker menu, press the **Sig Count On/Off** softkey.
The result of frequency counting is displayed in the selected resolution in the marker field at the top edge of the screen.

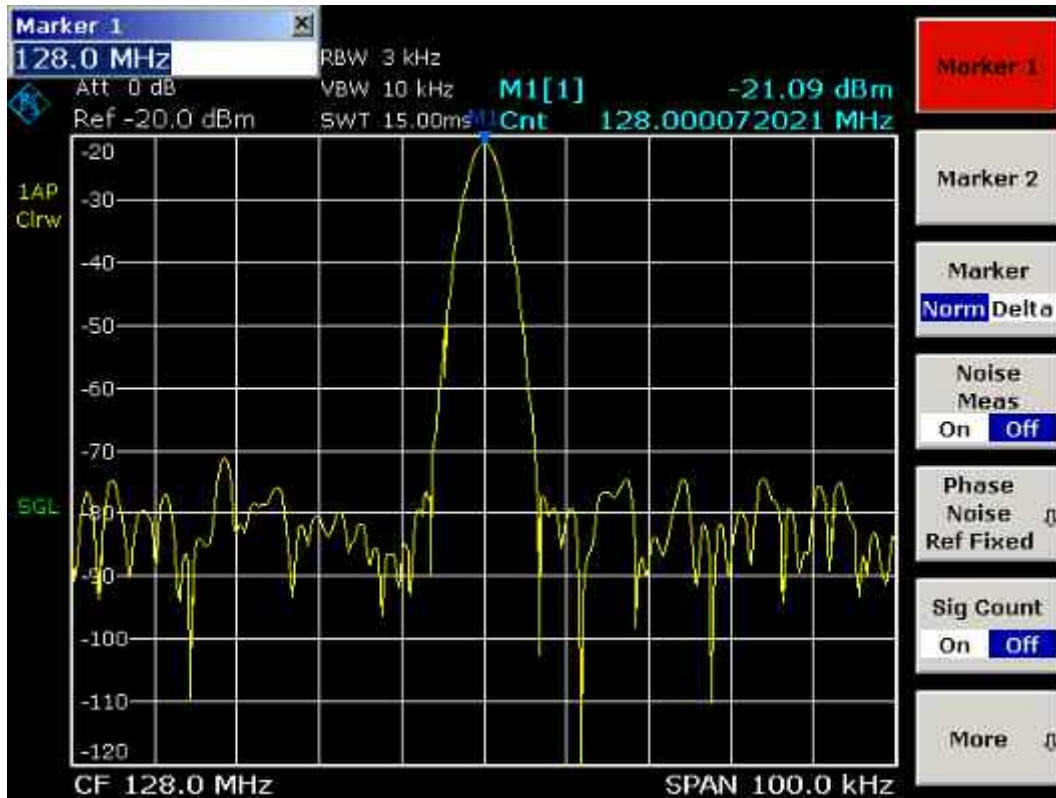

Fig. 5–1 Measurement of the frequency with the frequency counter

Note: Obtaining a correct result when measuring the frequency with the internal frequency counter requires that an RF sinusoidal signal or a spectral line be present. The marker must be located more than 25 dB above the noise level to ensure that the specified measurement accuracy is adhered to.

Measuring Harmonics of Sinusoidal Signals

Measuring the harmonics of a signal is a very common task that can be optimally performed by using a spectrum analyzer.

In the following example, the generator signal with 128 MHz and –20 dBm is used again.

Measuring the Suppression of the First and Second Harmonic of an Input Signal

1. Set the spectrum analyzer to the default state.
 - Press the **PRESET** key.
The R&S ESL is in the default state.
2. Set the start frequency to 100 MHz and the stop frequency to 400 MHz.
 - Press the **FREQ** key.
 - Press the **Start** softkey and enter *100 MHz*.
 - Press the **Stop** softkey and enter *400 MHz*.
The R&S ESL displays the fundamental and the first and second harmonics of the input signal.
3. To average (smooth) the noise, reduce the video bandwidth.
 - Press the **BW** key.
 - Press the **Video BW Manual** softkey and enter 100 kHz.
4. Activate the marker.
 - Press the **MKR** key.
Marker 1 is activated and positioned to the signal maximum (fundamental at 128 MHz). The level and frequency of the marker is displayed in the marker field.
5. Activate the delta marker and measure the harmonic suppression.
 - In the marker menu, press the **Marker 2** softkey.
Marker 2 is activated as a delta marker (D 2 [1]). It is automatically set on the largest harmonic of the signal. The frequency offset and level offset from marker 1 are displayed in the marker field at the top edge of the screen.
 - In the marker menu, press the **More** **↓** softkey and then the **Marker 3** softkey.
Marker 3 is activated as a delta marker (D 3 [1]). It is automatically set on the next largest harmonic of the signal. The frequency offset and level offset from marker 1 on the fundamental are displayed in the marker field at the top edge of the screen. (see Fig. 5–2)

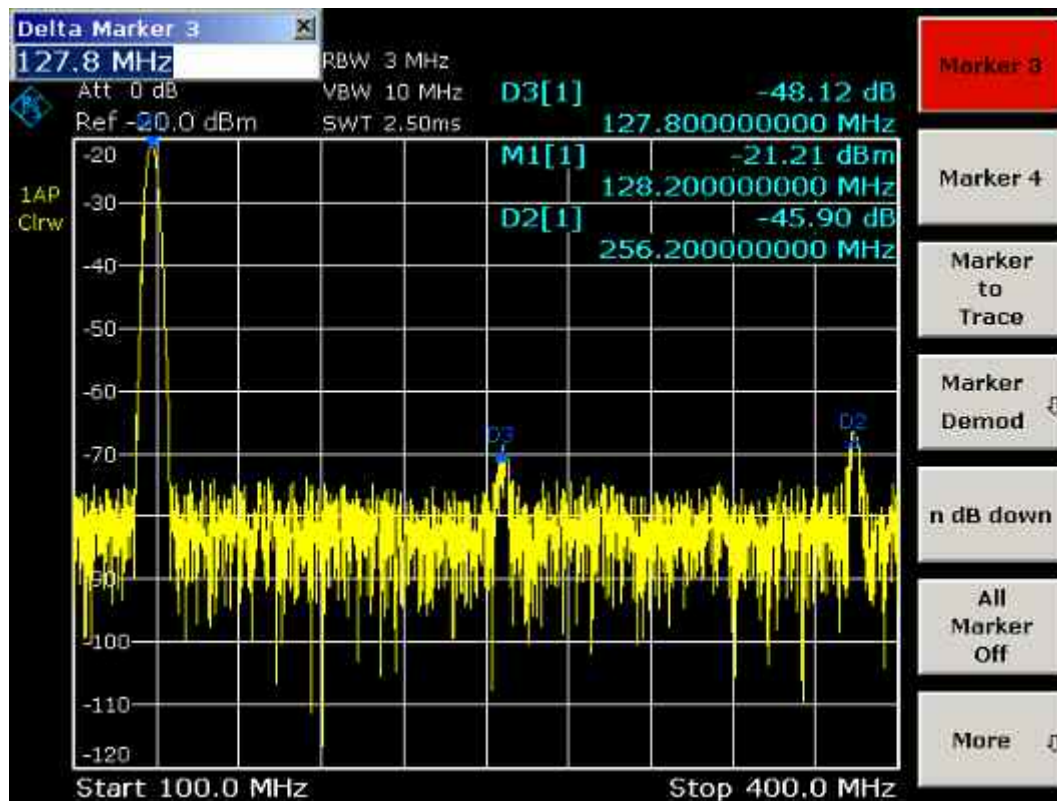

Fig. 5–2 Measuring the harmonic suppression of the internal reference generator. Delta markers D2 [1] and D3 [1] show the offset of the first and second harmonics from the fundamental.

Reducing Noise

The spectrum analyzer offers three means of effectively differentiating the harmonics of a signal from the noise:

- Reducing the video bandwidth
- Averaging the trace
- Reducing the resolution bandwidth

Reducing the video bandwidth and averaging the traces cause the noise from the analyzer or the DUT to be reduced, depending on which component is larger. Both averaging methods reduce the measurement uncertainty particularly in the case of small signal-to-noise ratios, because the measurement signal is also separated from the noise.

1. Reducing the noise by reducing the video bandwidth.
 - Press the **BW** key.
 - Press the **Video BW Manual** softkey.
 - Using the rotary knob (turning it counterclockwise), reduce the video bandwidth to 1 kHz (for example), or enter *1 kHz*.

This clearly smooths the noise, and the sweep time is increased to 200 ms. In other words, the measurement will clearly take more time. The video bandwidth that is displayed is marked with an asterisk (*VBW) to indicate that it is no longer coupled to the resolution bandwidth (see Fig. 5–3).



Fig. 5–3 Suppression of noise during harmonics measurement by reducing video bandwidth

2. Recouple the video bandwidth to the resolution bandwidth.

- Press the **BW** key.
- Press the **Video BW Auto** softkey.

3. Reduce the noise by averaging the curve.

- Press the **TRACE** key.
- Press the **Trace Mode** softkey.
- Press the **Average** softkey.

The noise component of the trace is smoothed by averaging 10 successive traces.

4. Switch off trace averaging.

- Press the **Trace Mode** softkey.
- Press the **Clear Write** softkey.

5. Reduce the noise by reducing the measurement bandwidth.

The noise is reduced in proportion to the bandwidth by reducing the resolution bandwidth, i.e. reducing the resolution bandwidth by a factor of 10 also reduces the noise by a factor of 10 (which corresponds to 10 dB). The amplitude of sinusoidal signals is not affected by reducing the resolution bandwidth.

6. Set the resolution bandwidth to 10 kHz.

- Press the **BW** key.
- Press the **Res BW Manual** softkey and enter *10 kHz*.

The noise decreases by approx. 25 dB with respect to the previous setting. Since the video bandwidth is coupled to the resolution bandwidth, it is reduced to 30 kHz in proportion to the resolution bandwidth. This causes the sweep time to increase to 3.0 seconds.

7. Reset the resolution bandwidth (couple it to the span)
 - In the bandwidth menu, press the **Res BW Auto** softkey.

Measuring Signal Spectra with Multiple Signals

Separating Signals by Selecting the Resolution Bandwidth

A basic feature of a spectrum analyzer is the ability to separate the spectral components of a mixture of signals. The resolution at which the individual components can be separated is determined by the resolution bandwidth. Selecting a resolution bandwidth that is too large may make it impossible to distinguish between spectral components, i.e. they are displayed as a single component.

An RF sinusoidal signal is displayed by means of the passband characteristic of the resolution filter (RBW) that has been set. Its specified bandwidth is the 3 dB bandwidth of the filter.

Two signals with the same amplitude can be resolved if the resolution bandwidth is smaller than or equal to the frequency spacing of the signal. If the resolution bandwidth is equal to the frequency spacing, the spectrum display shows a level drop of 3 dB precisely in the center of the two signals. Decreasing the resolution bandwidth makes the level drop larger, which thus makes the individual signals clearer.

Higher spectral resolution at a narrower bandwidth is accomplished through longer sweep times at the same span. Reducing the resolution bandwidth by a factor of 3 increases the sweep time by a factor of 9.

Separating Two Signals with a Level of -30 dBm each at a Frequency Spacing of 30 kHz

Test setup:

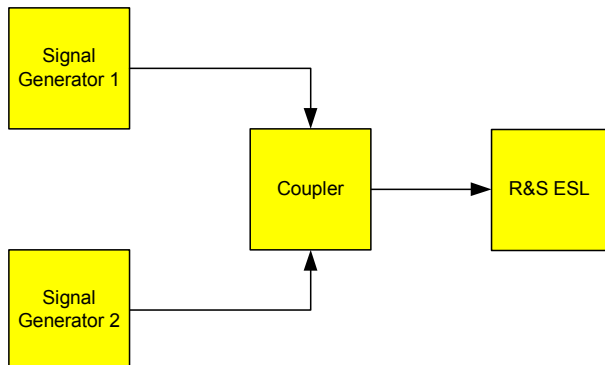

Signal generator settings (e.g. R&S SMU):

	Level	Frequency
Signal generator 1	-30 dBm	128,00 MHz
Signal generator 2	-30 dBm	128,03 MHz

Procedure:

- Set the spectrum analyzer to the default state.
 - Press the **PRESET** key.
The R&S ESL is set to its default state.
- Set the center frequency to 128.015 MHz and the frequency span to 300 kHz.
 - Press the **FREQ** key and enter *128.015 MHz*.
 - Press the **SPAN** key and enter *300 kHz*.
- Set the resolution bandwidth to 30 kHz and the video bandwidth to 1 kHz.
 - Press the **BW** key.
 - Press the **Res BW Manual** softkey and enter *30 kHz*.
 - Press the **Video BW Manual** softkey and enter *1 kHz*.

The two signals can be clearly distinguished by a 3 dB level drop in the center of the screen.

Note: *The video bandwidth is set to 1 kHz in order to make the level drop in the center of the two signals clearly visible. At larger video bandwidths, the video voltage that results from envelope detection is not sufficiently suppressed. This produces additional voltages, which are visible in the trace, in the transition area between the two signals.*

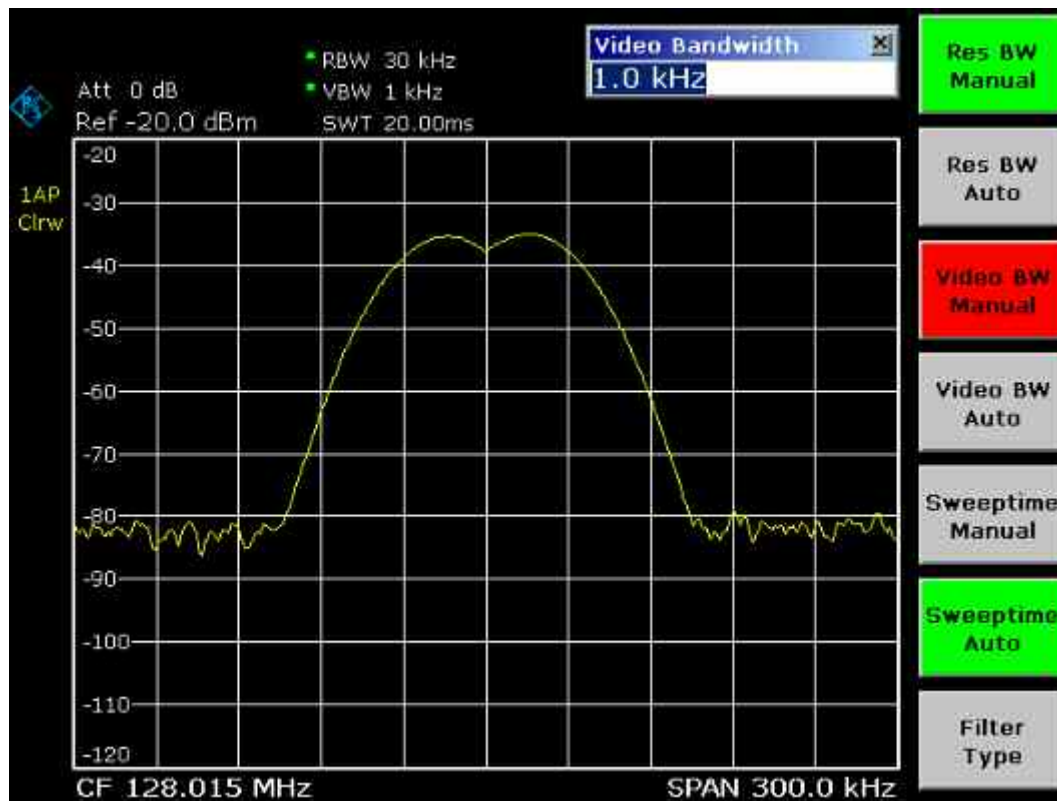

Fig. 5–4 Measurement of two equally–leveled RF sinusoidal signals with the resolution bandwidth which corresponds to the frequency spacing of the signals

Note: *The level drop is located exactly in the center of the screen only if the generator frequencies exactly match the frequency display of the R&S ESL. To achieve exact matching, the frequencies of the generators and the R&S ESL must be synchronized.*

4. Set the resolution bandwidth to 100 kHz.
 - In the bandwidth menu, press the **Res BW Manual** softkey and enter 100 kHz. It is no longer possible to clearly distinguish the two generator signals.

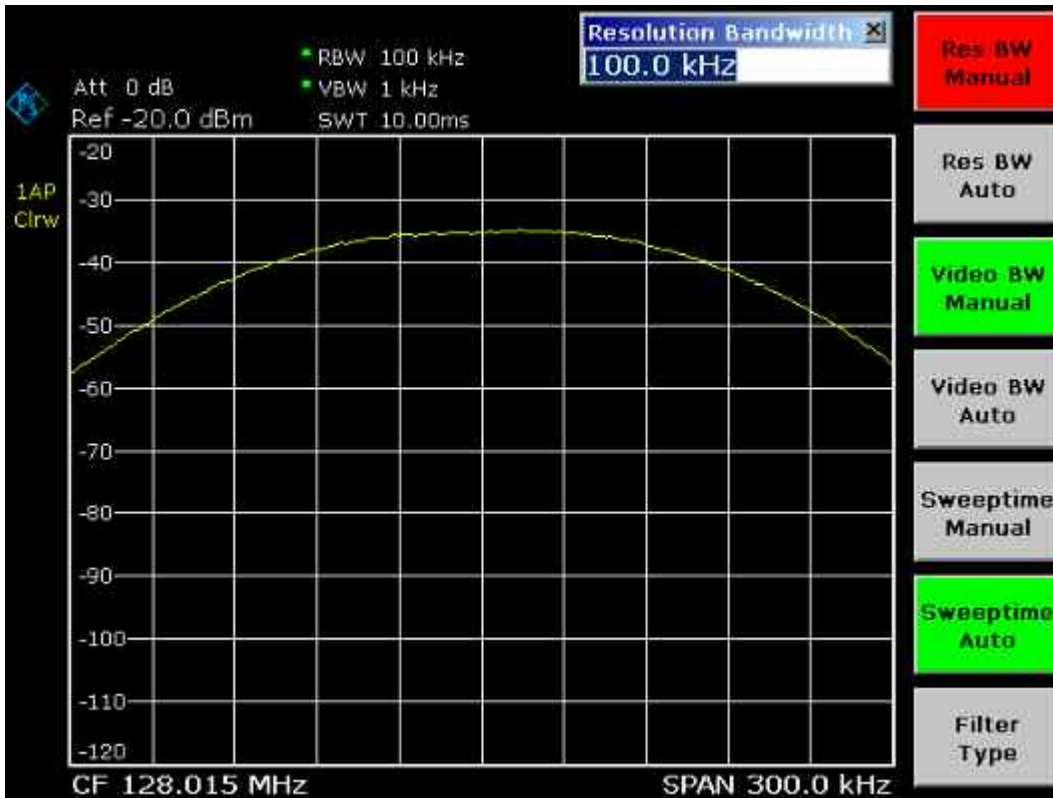

Fig. 5–5 Measurement of two equally–leveled RF sinusoidal signals with a resolution bandwidth which is larger than their frequency spacing

Note: *The resolution bandwidth (RBW) can be reduced again by turning the rotary knob counterclockwise, thus yielding a higher frequency resolution.*

5. Set the resolution bandwidth to 1 kHz.

- Turn the rotary knob counterclockwise until the bandwidth indicates 1 kHz.

The two generator signals are shown with high resolution. However, the sweep time becomes noticeably longer (600 ms), since it increases at a rate of $1/RBW^2$. At smaller bandwidths, the noise display decreases simultaneously (10 dB decrease in noise floor per a decrease in bandwidth by a factor of 10).

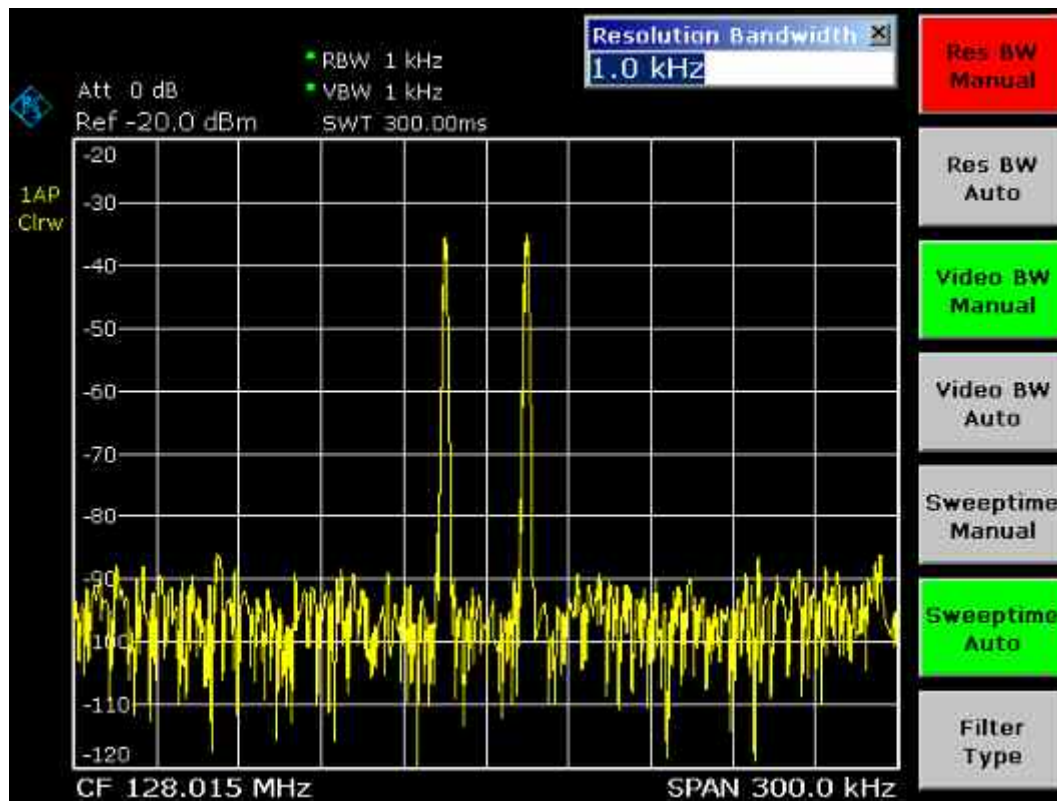

Fig. 5–6 Measurement of two equally–leveled RF sinusoidal signals with a resolution bandwidth (1 kHz) which is clearly smaller than their frequency spacing

6. Activate the FFT bandwidths.

- Press the **Filter Type** softkey.
- In the **Filter Type** dialog box, select **FFT**.

IF filtering is now performed using the FFT algorithm. The sweep time decreases significantly from 600 ms to 15 ms (a factor of 40). The display update rate also increases by almost the same ratio.

Measuring the Modulation Depth of an AM–Modulated Carrier (Span > 0)

In the frequency range display, the AM side bands can be resolved with a narrow bandwidth and measured separately. The modulation depth of a carrier modulated with a sinusoidal signal can then be measured. Since the dynamic range of a spectrum analyzer is very large, extremely small modulation depths can also be measured precisely. For this purpose, the R&S ESL provides measurement routines that directly output the modulation depth numerically in %.

Test setup:

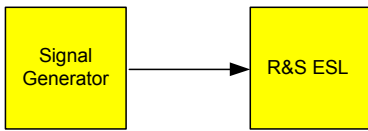

Signal generator settings (e.g. R&S SMU):

Frequency: 128 MHz
 Level: -30 dBm
 Modulation: 50 % AM, 10 kHz AF

Procedure:

1. Set the spectrum analyzer to the default state.
 - Press the **PRESET** key.
 - The R&S ESL is set to its default state.
2. Set the center frequency to 128 MHz and span to 50 kHz.
 - Press the **FREQ** key and enter *128 MHz*.
 - Press the **SPAN** key and enter *50 kHz*.
3. Activate the marker function for measuring the AM modulation depth.
 - Press the **MEAS** key.
 - Press the **AM Mod Depth** softkey.

The R&S ESL automatically sets a marker to the carrier signal in the center of the diagram and one delta marker each to the upper and lower AM sidebands. The R&S ESL calculates the AM modulation depth from the level differences of the delta markers to the main marker and outputs the numeric value in the marker field.

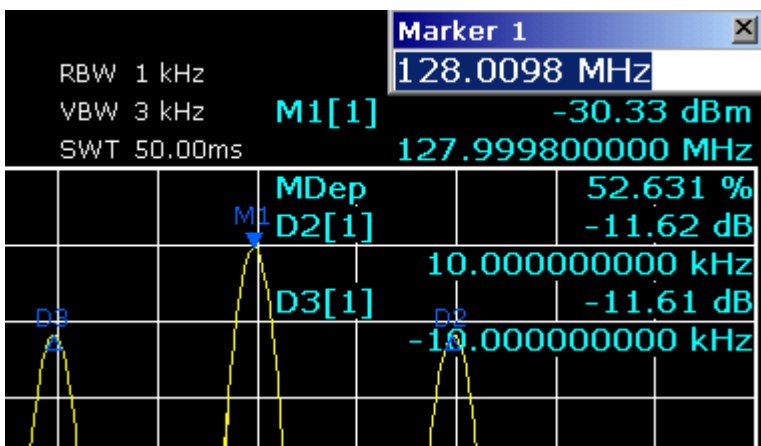

Fig. 5–7 Measurement of the AM modulation depth. The modulation depth is displayed as **MDEP**. The frequency of the AF signal can be obtained from the frequency display of the delta marker.

Measuring of AM–Modulated Signals

The spectrum analyzer rectifies the RF input signal and displays it as a magnitude spectrum. The rectification also demodulates AM–modulated signals. The AF voltage can be displayed in zero span if the modulation sidebands fall within the resolution bandwidth.

Displaying the AF of an AM–Modulated Signal (Zero Span)

Test setup:

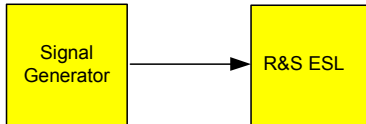

Signal generator settings (e.g. R&S SMU):

Frequency: 128 MHz
 Level: 0 dBm
 Modulation: 50 % AM, 1 kHz AF

Procedure:

1. Set the spectrum analyzer to the default state.
 - Press the **PRESET** key.
 - The R&S ESL is set to its default state.
2. Set the center frequency to 128 MHz and the span to 0 Hz.
 - Press the **FREQ** key and enter *128 MHz*.
 - Press the **SPAN** key and enter *0 Hz* or press the **Zero Span** softkey.
3. Set the reference level to +6 dBm, the display range to linear and the unit to Volt.
 - Press the **AMPT** key and enter *6 dBm*.
 - Press the **Range Linear** softkey.
 - Press the **More ↓** softkey
 - Press the **Unit** softkey and select Volt.
4. Triggering in response to the AF signal by using the video trigger to produce a static image.
 - Press the **TRIG** key.
 - Press the **Trg/Gate Source** softkey and select **Video** using the arrow keys.
 - Press the **Trg/Gate Level** softkey and enter *50%*.

The trigger level is displayed as a horizontal line across the entire measurement diagram. The R&S ESL displays the 1 kHz AF signal as a static image in zero span. The AF can be listened to by using a headset.

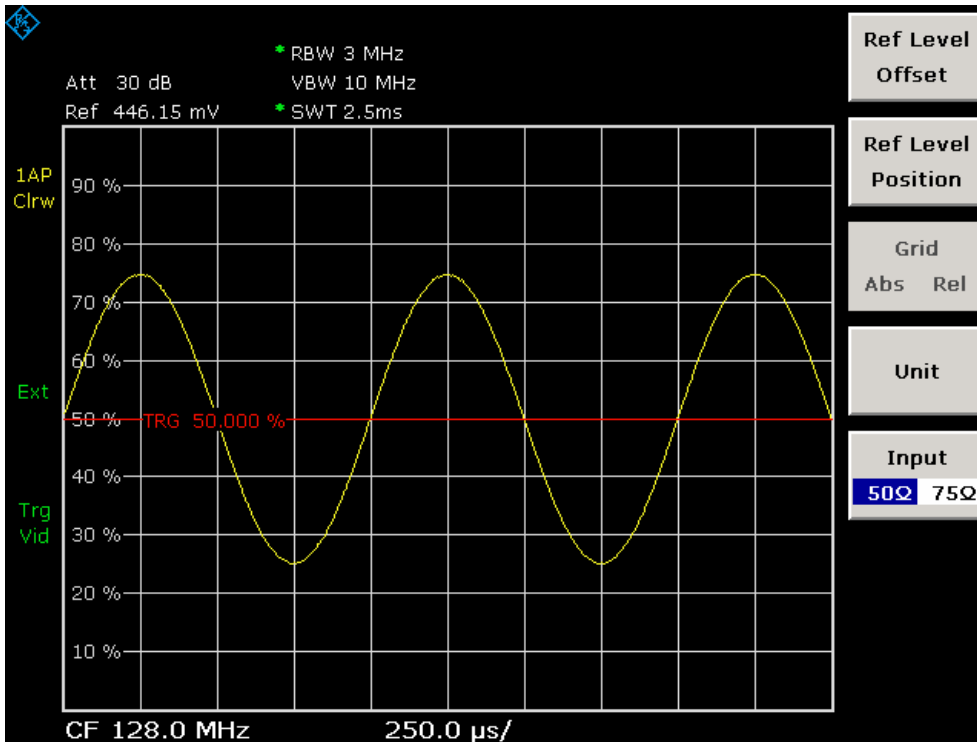

Fig. 5–8 Measurement of the AF signal of a carrier that is AM–modulated with 1 kHz

5. Activate the internal AM demodulator.

- Press the **MKR** key.
- Press the **More** ↓ softkey.
- Press the **Marker Demod** softkey.

The R&S ESL automatically switches on the AM audio demodulator and opens the **Volume** edit dialog box to regulate up the volume. A 1 kHz tone can be heard over headset.

Measurements in Zero Span

In the case of radio transmission systems that use the TDMA method (e.g. GSM or IS136), transmission quality is determined not only by spectral characteristics but also by characteristics in zero span. A timeslot is assigned to each user since several users share the same frequency. Smooth operation is ensured only if all users adhere exactly to their assigned timeslots.

Both the power during the send phase as well as the timing and duration of the TDMA burst, and rise and fall times of the burst, are important.

Measuring the Power Characteristic of Burst Signals

For measuring power in zero span, the R&S ESL offers easy-to-use functions that measure the power over a predefined time.

Measuring the Power of a GSM Burst During the Activation Phase

Test setup:

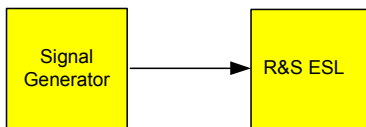

Signal generator settings (e.g. R&S SMU):

Frequency: 890 MHz

Level: 0 dBm

Modulation: GSM, one timeslot activated

Procedure:

1. Set the spectrum analyzer to the default state.
 - Press the **PRESET** key.
The R&S ESL is set to its default state.
2. Set the center frequency to 890 MHz, the span to 0 Hz and the resolution bandwidth to 1 MHz.
 - Press the **FREQ** key and enter *890 MHz*.
 - Press the **SPAN** key and enter *0 Hz*, or press the **Zero Span** softkey.
3. Set the reference level of the R&S ESL to 10 dBm (= level of the signal generator +10 dB).
 - Press the **AMPT** key and enter *10 dBm*.
4. Set the sweep time to 1 ms.
 - Press the **SWEEP** key.
 - Press the **Sweptime Manual** softkey and enter *1 ms*.
The R&S ESL shows the GSM burst continuously across the display.
5. By using the video trigger, triggering on the rising edge of the burst.
 - Press the **TRIG** key.
 - Press the **Trg/Gate Source** softkey and select **Video** using the arrow keys.
 - Press the **Trg/Gate Level** softkey and enter *70%*.

The R&S ESL shows a static image with the GSM burst at the start of the trace. The trigger level is displayed as a horizontal line labeled with the absolute level for the trigger threshold in the measurement diagram.

6. Configure power measurement in zero span.

- Press the **MEAS** key.
- Press the **Time Domain Power** softkey to open the submenu.
- Switch the **Limits** softkey to **On**.
- Press the **Left Limit** softkey.
- By turning the rotary knob clockwise, move the vertical line to the start of the burst.
- Press the **Right Limit** softkey.
- By turning the rotary knob counterclockwise, set the second vertical line to the end of the burst.

The R&S ESL displays the average (mean) power during the activation phase of the burst.

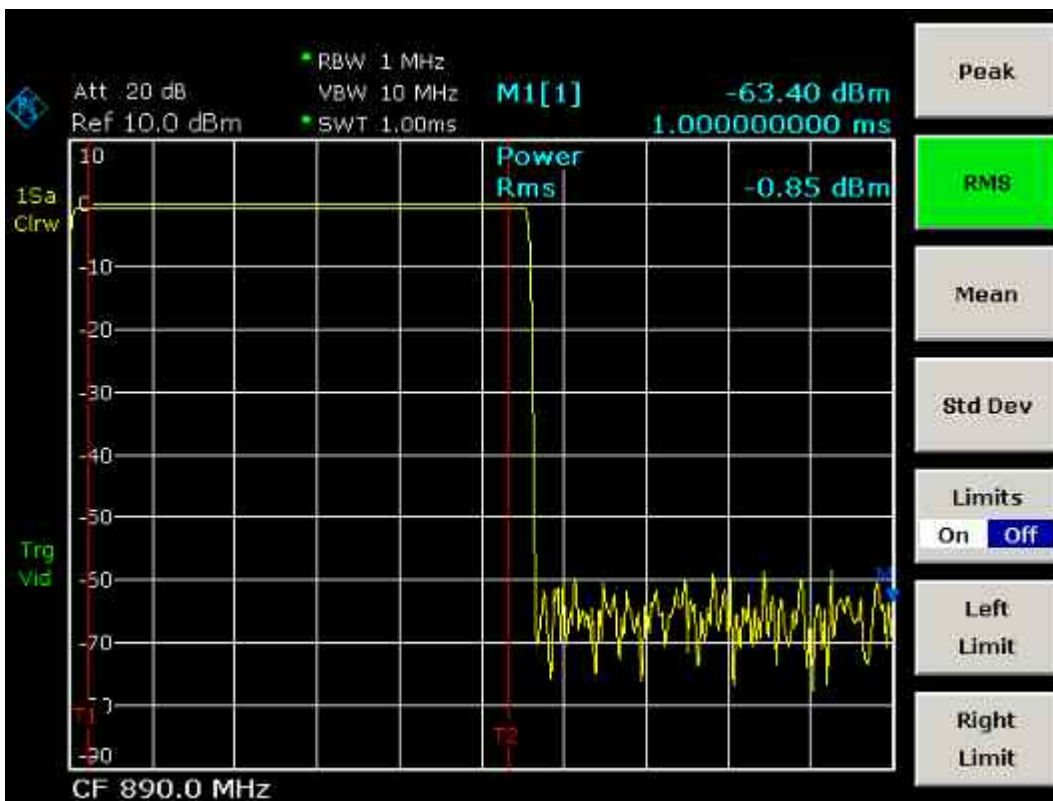
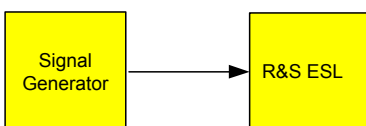

Fig. 5-9 Measurement of the average power during the burst of a GSM signal

Measuring the Edges of a GSM Burst with High Time Resolution

Because of the high time resolution of the R&S ESL at the 0 Hz display range, the edges of TDMA bursts can be measured precisely. The edges can be shifted to the screen area by using the trigger offset.

Test setup:



Signal generator settings (e.g. R&S SMU):

Frequency: 890 MHz
 Level: 0 dBm
 Modulation: GSM, one timeslot activated

Procedure:

The measurement is based on the setting in the example above for measuring the power of the GSM during the activation phase.

- Switch off the power measurement.
 - Press the **MEAS** key.
 - Press the **All Functions Off** softkey.
- Increase the time resolution to 100 μ s.
 - Press the **SWEEP** key.
 - Press the **Sweeptime Manual** softkey and enter 100 μ s.
- Using the trigger softkey, shift the rising edge of the GSM burst to the center of the screen.
 - Press the **TRIG** key.
 - Press the **Trigger Offset** softkey.
 - By turning the rotary knob counterclockwise, move the trigger offset until the burst edge can be seen in the center of the screen, or enter -50μ s.

The R&S ESL displays the rising edge of the GSM burst.



Fig. 5–10 Rising edge of the GSM burst displayed with high time resolution

4. Using the trigger offset, move the falling edge of the burst to the center of the screen.
 - Switch the **Trg/Gate Polarity** softkey to **Neg**.

The R&S ESL displays the falling edge of the GSM burst.

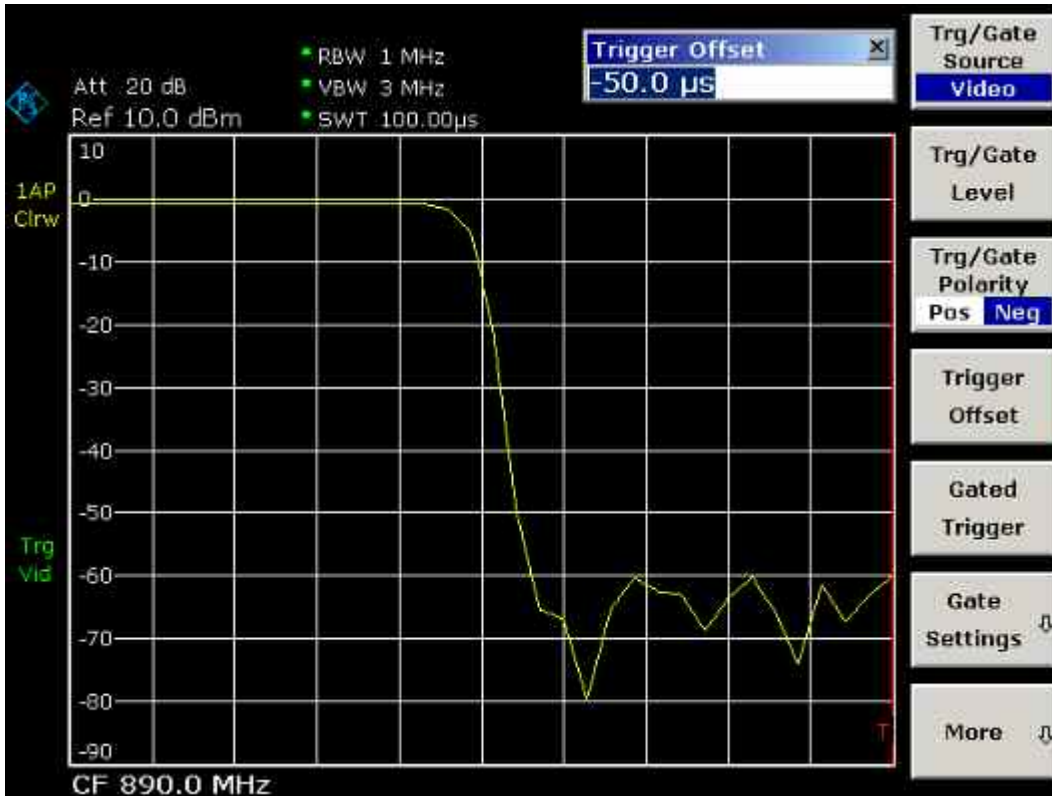

Fig. 5–11 Falling edge of the GSM burst displayed with high time resolution

Measuring the Signal-to-Noise Ratio of Burst Signals

When TDMA transmission methods are used, the signal-to-noise ratio or the deactivation dynamic range can be measured by comparing the power values during the activation phase and the deactivation phase of the transmission burst. For this purpose, the R&S ESL provides the function for measuring absolute and relative power in zero span. In the following example, the measurement is performed using a GSM burst.

Signal-to-Noise Ratio of a GSM Signal

Test setup:

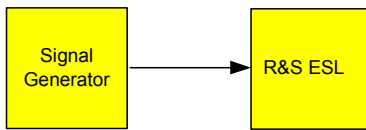

Signal generator settings (e.g. R&S SMU):

Frequency: 890 MHz

Level: 0 dBm

Modulation: GSM, one time slot is switched on

Procedure:

1. Set the spectrum analyzer to the default state.
 - Press the **PRESET** key.
The R&S ESL is set to its default state.
2. Set the center frequency to 890 MHz, the span to 0 Hz and the resolution bandwidth to 1 MHz.
 - Press the **FREQ** key and enter *890 MHz*.
 - Press the **SPAN** key and enter *0 Hz* or press the **Zero Span** softkey.
 - Press the **BW** key.
 - Press the **Res BW Manual** softkey and enter *1 MHz*.
3. Set the reference level of the R&S ESL to 0 dBm (= level of the signal generator).
 - Press the **AMPT** key and enter *0 dBm*.
4. Set the sweep time to 2 ms.
 - Press the **SWEEP** key.
 - Press the **Sweeptime Manual** softkey and enter *2 ms*.
The R&S ESL shows the GSM burst continuously across the display.
5. Use the trigger source **Video** and the trigger polarity **Pos** to trigger on the rising edge of the burst and shift the start of burst to the center of the screen.
 - Press the **TRIG** key.
 - Press the **Trg/Gate Source** softkey and select **Video** using the arrow keys.
 - Press the **Trg/Gate Level** softkey and enter *70%*.
The R&S ESL shows a static image with the GSM burst at the start of the trace.
 - Press the **Trigger Offset** softkey and enter *-1 ms*.
The R&S ESL shows the GSM burst in the right-hand half of the measurement diagram.
6. Configure the power measurement in zero span.

- Press the **MEAS** key.
 - Press the **Time Domain Power** softkey to open the submenu.
 - Switch the **Limits** softkey to **On**.
 - Press the **Left Limit** softkey.
 - Using the rotary knob, move the vertical line to the start of the burst.
 - Press the **Right Limit** softkey.
 - Using the rotary knob, move the second vertical line to the end of the burst.
- The R&S ESL displays the power during the activation phase of the burst.

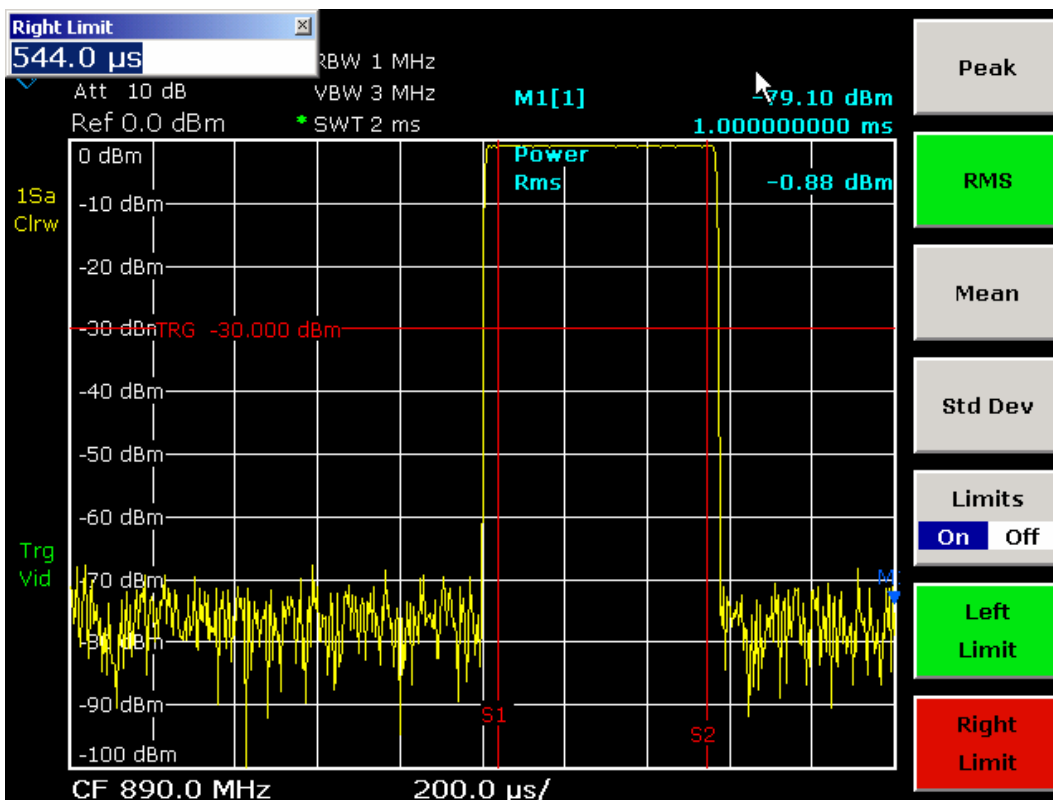

Fig. 5–12 Power measurement during the activation phase of the burst

7. Measure the power during the deactivation phase of the burst.
 - Press the **TRIG** key.
 - Switch the **Trg/Gate Polarity** softkey to **Neg**.

The R&S ESL initiates triggering in response to the falling edge of the burst. This shifts the burst to the left-hand half of the measurement diagram. The power is measured in the deactivation phase. The start of the burst is shifted to the center of the screen and the power during the deactivation phase is measured.

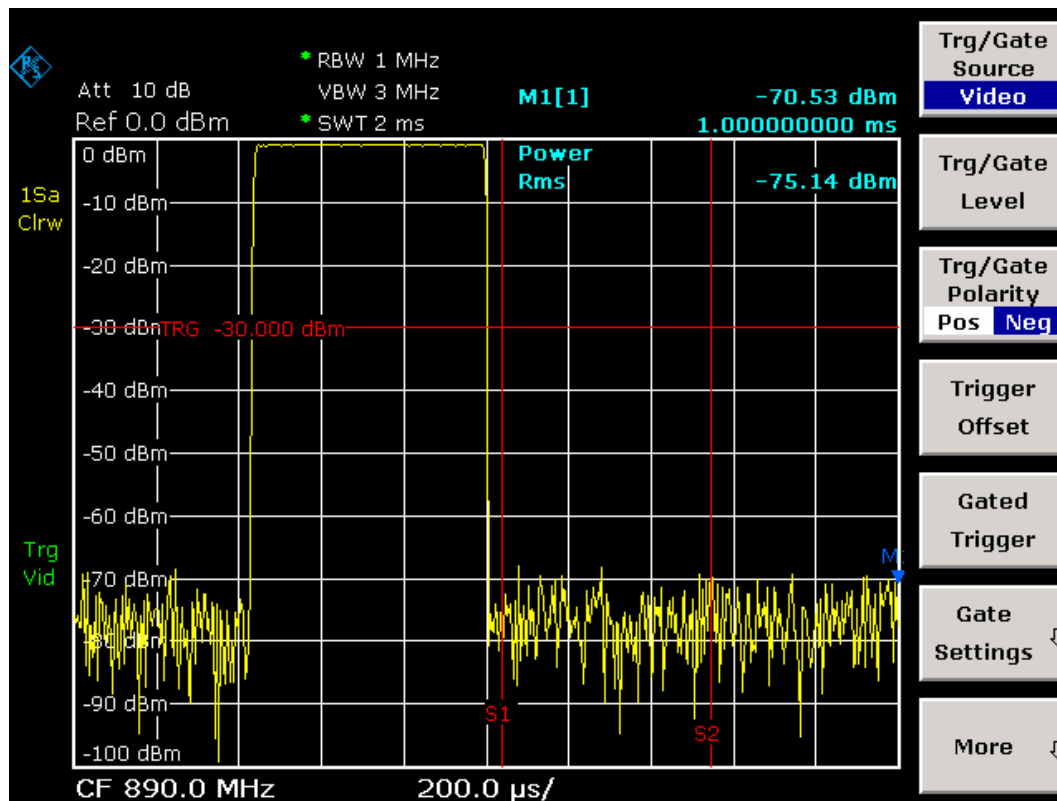

Fig. 5–13 Measurement of the signal-to-noise ratio of a GSM burst signal in zero span.

Measuring of FM-Modulated Signals

Since spectrum analyzers can display only the magnitude of the measurement signal by using the envelope detector, the modulation of FM-modulated signals cannot be measured directly as in the case of AM-modulated signals. The voltage at the output of the envelope detector remains constant for FM-modulated signals as long as the frequency deviation of the signal is located within the flat part of the passband characteristic of the resolution filter that is used. Amplitude variation occurs only if the instantaneous frequency extends into a falling edge of the filter curve. This behavior can be used to demodulate FM-modulated signals. The center frequency of the analyzer is set in such a manner that the nominal frequency of the measurement signal is located on a filter edge (below or above the center frequency). The resolution bandwidth and the frequency offset must be selected in such a manner that the instantaneous frequency is located in the linear part of the filter edge. As a result, the frequency variation of the FM-modulated signal is transformed into an amplitude variation that can be displayed on screen in zero span.

Displaying the AF of an FM–Modulated Carrier

Test setup:

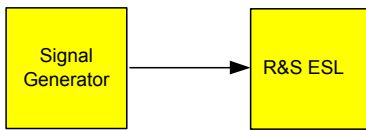

Signal generator settings (e.g. R&S SMU):

Frequency: 128 MHz

Level: –20 dBm

Modulation: FM 0 kHz deviation (i.e. FM modulation is deactivated), 1 kHz AF

Procedure:

1. Set the spectrum analyzer to the default state.
 - Press the **PRESET** key.
The R&S ESL is set to its default state.
2. Set the center frequency to 127.50 MHz and the span to 300 kHz.
 - Press the **FREQ** key and enter *127.50 MHz*.
 - Press the **SPAN** key and enter *300 kHz*.
3. Set the resolution bandwidth to 300 kHz.
 - Press the **BW** key.
 - Press the **Res BW Manual** softkey and enter *300 kHz*.
 - Press the **Video BW Manual** softkey and enter *30 kHz*.
4. Set the display range to 20 dB and shift the filter trace to the center of the screen.
 - Press the **AMPT** key.
 - Press the **Range Log** softkey and enter *20 dB*.
 - Press the **More** **↓** key.
 - Switch the **Grid** softkey to **Rel**.
 - Press the **▲** key.
 - Press the **Ref Level** softkey.
 - Using the rotary knob, set the reference level such that the filter edge at the center frequency intersects the –10 dB level line.

The filter edge of the 300 kHz filter is displayed. This corresponds to the demodulator characteristic for FM signals with a steepness of approx. 18 dB/140 kHz. This can be verified using marker and delta marker.

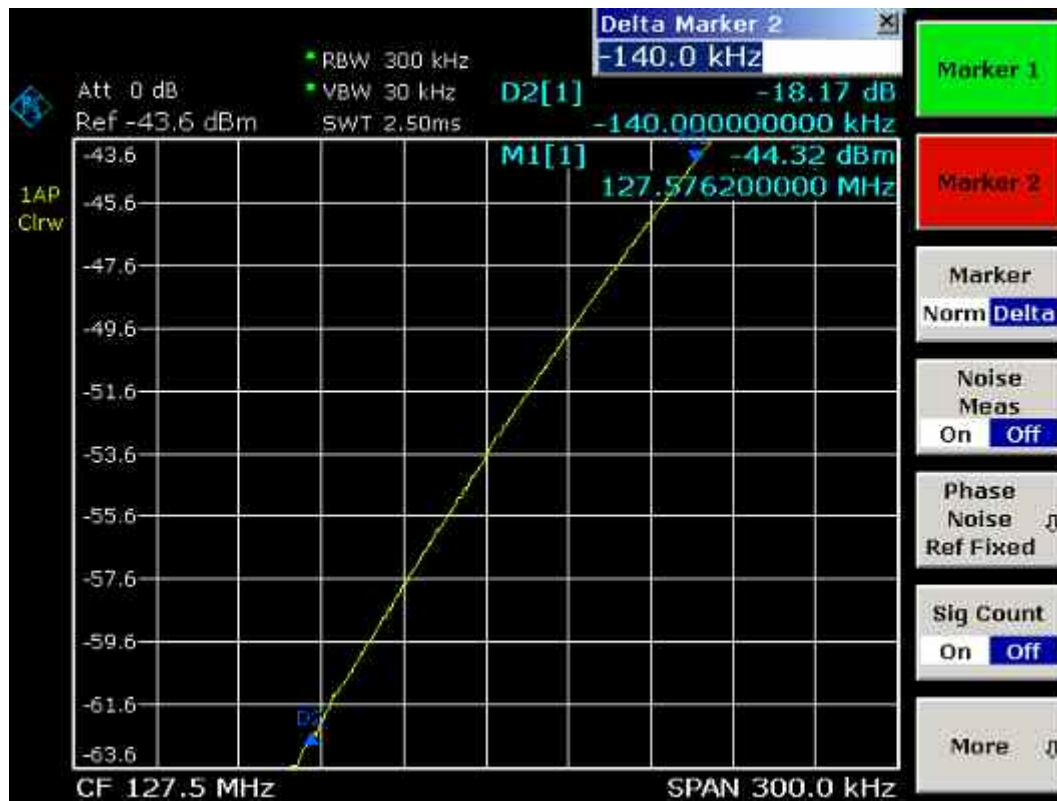

Fig. 5–14 Display of the filter edge of the 300 kHz filter as an FM discriminator characteristic

5. Set the FM deviation to 50 kHz on the signal generator.
6. Set the span to 0 Hz on the R&S ESL.
 - Press the **SPAN** key.
 - Press the **Zero Span** softkey.

The demodulated FM signal is displayed. The signal crosses the screen continuously.

7. Establish a stable display using video triggering.
 - Press the **TRIG** key.
 - Press the **Trg/Gate Source** softkey and select **Video** using the arrow keys.
 - Press the **Trg/Gate Level** softkey and enter **50%**.

A static image for the FM AF signal is produced.

Result: (-10 ± 5) dB; this yields a deviation of 100 kHz when the steepness of the demodulator characteristic is 5 dB/100 kHz.

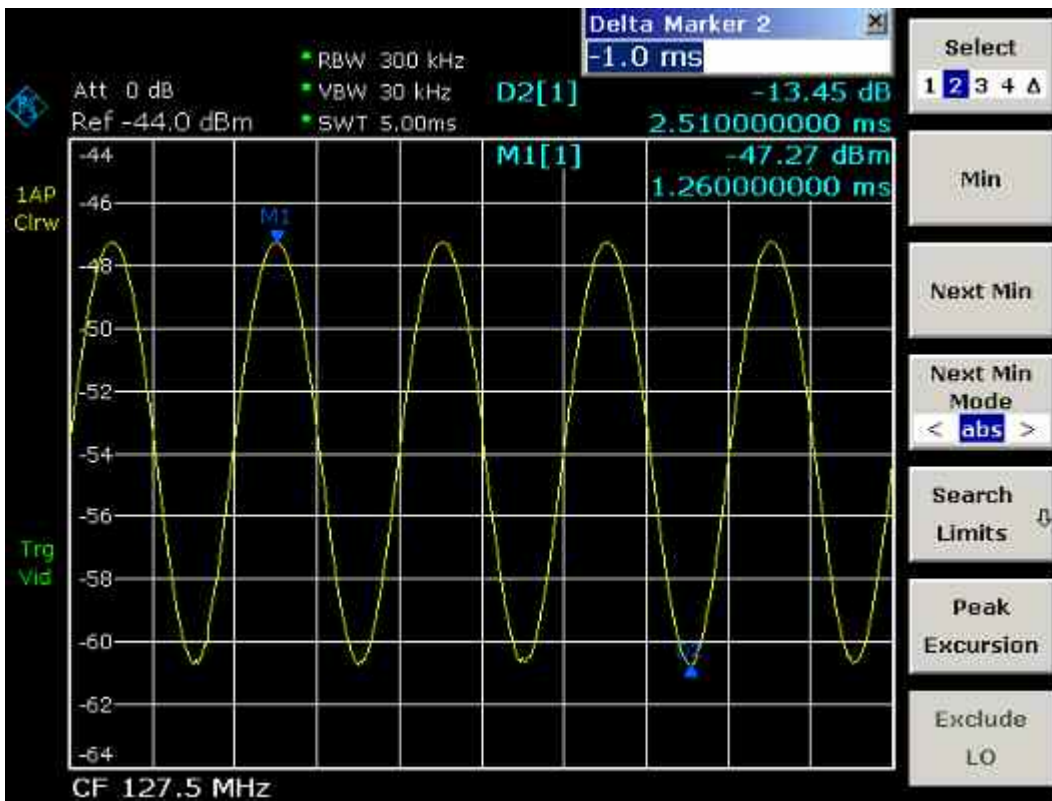

Fig. 5–15 Demodulated FM signal

8. Determine the deviation

- Press the **MKR** key.
Marker 1 is activated and placed on the peak of the curve.
- Press the **Marker 2** softkey.
- Press the **MKR →** key.
- Press the **More ↓** softkey.
- Press the **Min** softkey.

Marker 2 (delta marker) is placed on the minimum of the curve. The level difference is 13.4 dB, which corresponds to the peak-to-peak deviation. With the filter slope of 18 dB/140 kHz can be calculated:

$$\text{deviation} = \frac{1}{2} \times \frac{13.4 \times 140}{18} \text{ kHz} = \frac{1}{2} 104 \text{ kHz} = 52 \text{ kHz}$$

Storing and Loading Instrument Settings

The R&S ESL can store complete instrument settings together with instrument configurations and measurement data in a settings file. The data is stored on the built-in hard disk or – if selected – on a USB device (e.g. memory stick) or on a network drive. The hard disk has the drive name C:

In the default state, the current settings are stored. This includes the settings of the measurement functions, the activated limit lines and the active transducer factor.

Storing an Instrument Configuration (without Traces)

1. Press the **FILE** key.
2. Press the **Save** softkey.
The dialog box for instrument configurations is displayed. The **File Name** field is in edit mode and contains already a suggestion for a new name.

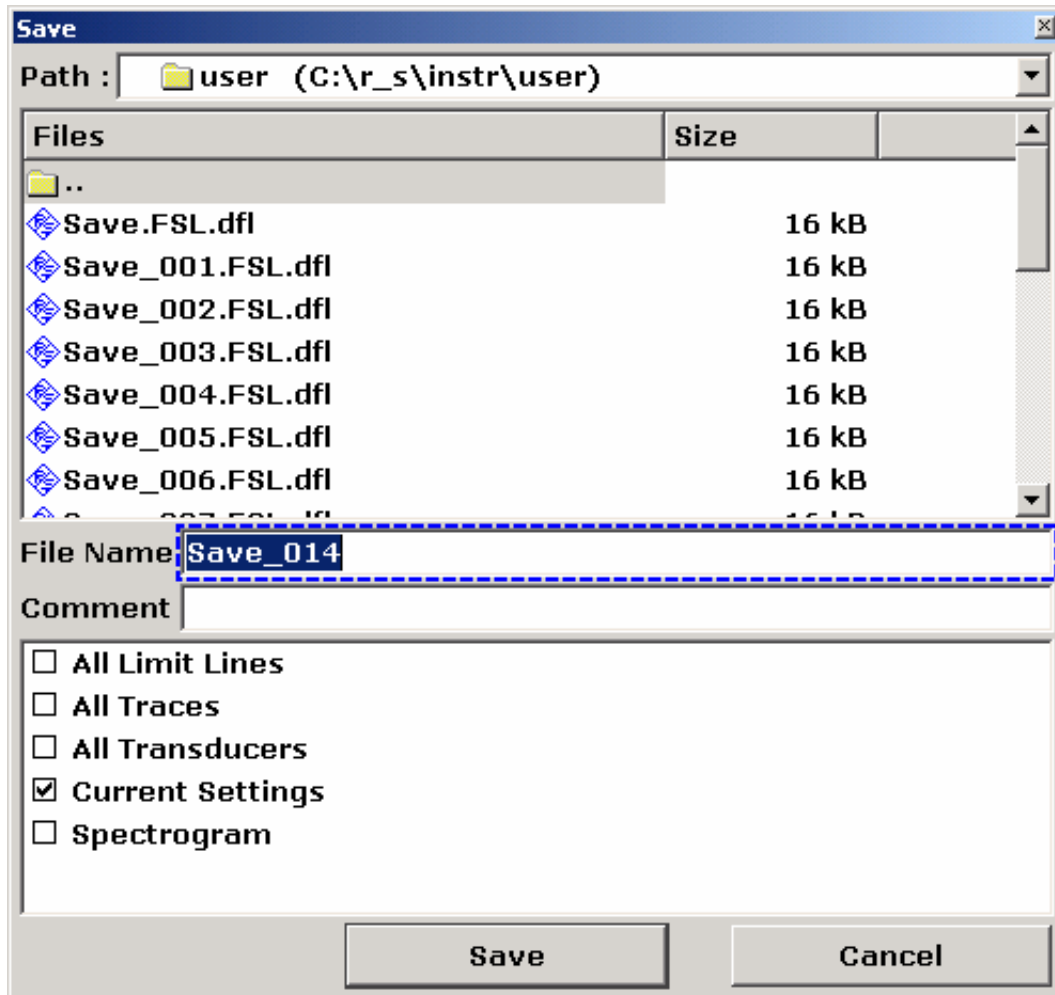

3. If you want to change the suggested name, enter a name for the settings file to be stored.
The name may contain letters and digits. Enter the name via the front panel keypad (for details on alphanumeric entries see chapter 4, "Basic Operations").
To store the file in a directory different to the default directory, change the path using the **Select Path** softkey (the directory is automatically used for any further save and recall operations).
4. Press the **Save File** softkey.
If the path is not changed, the settings file is stored under the default path for the instrument configurations (C:\R_S\Instr\user). The dialog box is closed.

Storing Traces

Before you can store traces, you must first select the corresponding item entry. For this purpose proceed as follows:

1. Press the **FILE** key.
2. Press the **Save** softkey.
3. If you want to change the suggested name, enter a file name.
4. Press the **Select Items** softkey to focus the items list.
5. Select the **All Traces** option using the arrow keys and confirm by pressing the **CHECKMARK** key.
6. Press the **FIELD RIGHT** key to set the focus on the **Save** button and confirm by pressing the **ENTER** key, or press the **▲** key to leave the submenu and press the **Save File** softkey.

Loading an Instrument Configuration (with Traces)

1. Press the **FILE** key.
2. Press the **Recall** softkey.
3. If necessary, select the path, under which the file to be loaded is stored.
 - Press the **Select Path** softkey and select a drive by using the arrow keys.
4. Define the settings file to be loaded. One of the following ways is possible:
 - a) By selecting the settings file from a list:
 - If you have changed the path, press the **Select File** softkey.
The focus is set on the files list again.
 - Using the rotary knob or arrow keys, focus the settings file to be loaded and confirm by pressing the rotary knob or the **ENTER** key.
 - b) By directly entering the settings file name:
 - Press the **Edit File Name** softkey.
 - Enter the name of the settings file to be loaded (which is a digit from 0 to 9 in the simplest case).
5. If you want to load traces:
 - Press the **Select Items** softkey to set the focus on the items list.
 - Select the **All Traces** option using the arrow keys and confirm by pressing the **CHECKMARK** key. The **All Traces** option is only available, if the selected file contains traces.
6. Press the **Recall File** softkey.
The settings file is loaded.

Note: *During loading, the R&S ESL detects which items the selected settings file contains and, if applicable, ignores any items that were selected but are not available.*

Configuring Automatic Loading

If the R&S ESL is switched on in the factory default state, it loads the instrument settings that it had when switched off (provided that it was switched off using the ON / STANDBY key on the front panel; see chapter 2, section "Preparing for Operation"). If the instrument is preset, it loads the default settings.

You can alter these settings and define a settings file to be loaded. This requires performing the following procedure. Be aware that the chosen settings file is loaded both during booting and preset.

1. Press the **FILE** key.
2. If the **Startup Recall** softkey is not activated, press it.
The **Startup Recall Setup** softkey is activated.
3. Press the **Startup Recall Setup** softkey.
The **Startup Recall** dialog box is displayed.
4. Focus the settings file to be loaded (DFL file) by using the arrow keys and confirm by pressing the **ENTER** key.
If you want to select the settings file from another directory, under **Path**, change the directory.

6 Brief Introduction to Remote Control

The instrument can be remote-controlled via the network (LAN interface). For details on configuring the LAN interface see chapter 2, section "Configuring the LAN Interface". Remote control via a GPIB interface is only provided with option R&S FSL-B10. For details on setting the interface see chapter 2, section "Setting the GPIB Interface".

The following programming examples are hierarchical in structure, i.e. the later examples are based on the preceding ones. This makes it possible to easily assemble a well-functioning program by using the modules of the program examples. More complex examples are provided in the Operating Manual, chapter 7 "Remote Control – Programming Examples"

Basic Steps in Remote Control Programming

The following examples explain how to program the instrument and can be used as a basis for solving enhanced programming tasks.

Visual Basic was used as the programming language. However, the programs can be implemented in other languages as well.

Note: In programming languages as C, C++ or programmes as MATLAB, NI Interactive Control, a backslash starts an escape sequence (e.g. “\n” is used to start a new line). In these programming languages and programmes, two backslashes instead of one must be used in remote commands, e.g. in [Storing Instrument Settings](#): instead of `MMEM:STOR:STAT 1, 'D:\USER\DATA\TEST1'` use `MMEM:STOR:STAT 1, 'D:\\USER\\DATA\\TEST1'`

Linking the Remote Control Library for Visual Basic

Programming notes:

- **Outputting text by using the print function**

Using the print method, this example displays the value of the variable `MyVar` in the **Immediate** window of the Visual Basic development environment. Note that the print method only applies to objects that can display text.

```
Debug.Print MyVar
```

- **Accessing the functions of the VISA32.DLL**

To enable users to create Visual Basic control applications, the file VISA32.BAS must be added to a project so that functions of the VISA32.DLL can be called. In addition, the file VPPTYPE.BAS must be added to the project. This file contains constants and definitions for error handling, timeout values, etc.

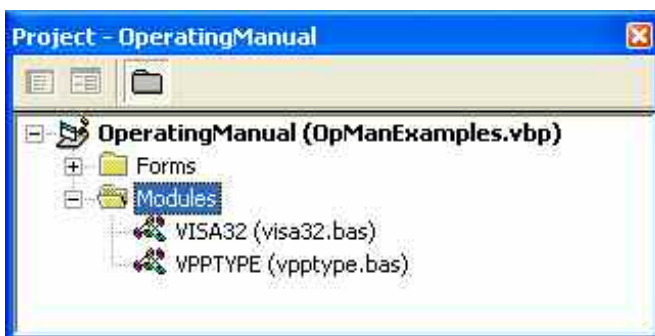

The modules `visa32.bas` and `vpptype.bas` can be found in the `<VXIpnPath>\WinNT\include` (typically `C:\VXIpnPath\WinNT\include`).

As an alternative a reference to the VISA32.DLL can be added to the project.

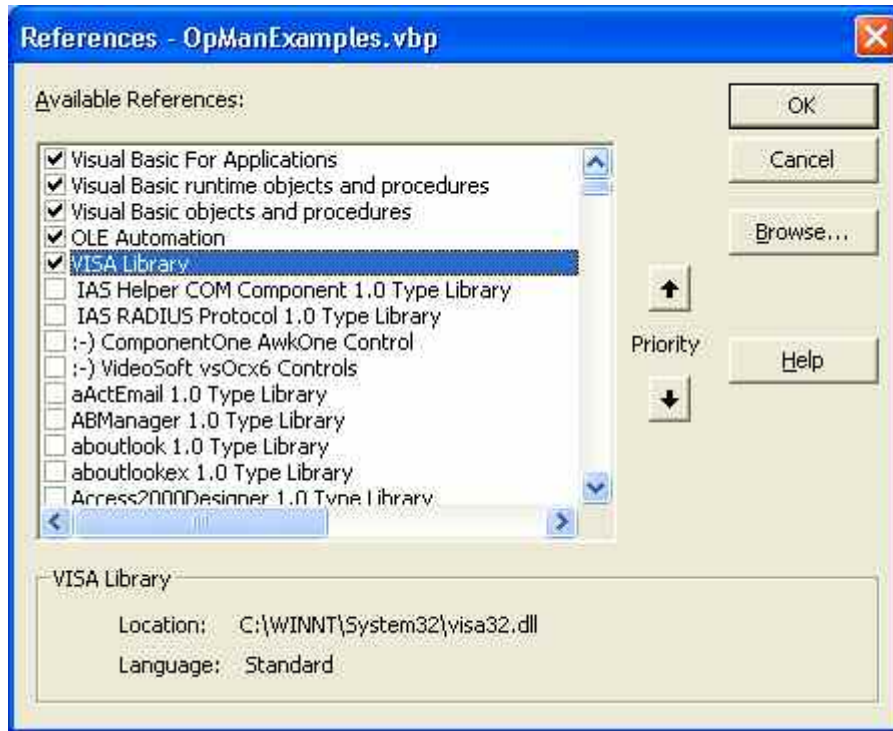

- **Creating a response buffer**

Since the DLL returns zero-terminated strings in responses, a string of sufficient length must be created before the functions `InstrRead()` and `ilrd()` are called, because Visual Basic inserts a length specification in front of the strings and this specification is not updated by the DLL. The following two means of creating the length specification for a string are provided:

- `Dim Rd as String * 100`
- `Dim Rd as String`
- `Rd = Space$(100)`

- **Creating Wrapper Procedures for Writing and Reading**

Since the VISA functions require command and response strings and their corresponding length in two separate parameters, the main program code is easier to read and maintain if the read and write functions are encapsulated. Here the procedure `InstrWrite()` encapsulates the function `viWrite()` and `InstrRead()` encapsulates `viRead()`. In addition these wrappers include status checking:

```
Public Sub InstrWrite(ByVal vi As Long, ByVal Cmd As String)
Dim status As Long
Dim retCount As Long

'Send command to instrument and check for status
status = viWrite(vi, Cmd, Len(Cmd), retCount)
'Check for errors - this will raise an error if status is not VI_SUCCESS
CALL CheckError(vi, status)

End Sub
```

```
Public Sub InstrRead(ByVal vi As Long, Response As String, ByVal count As Long,
retCount As Long)
Dim status As Long

'Initialize response string
Response = Space(count)
'...and read
status = viRead(vi, Response, count, retCount)
'Check for errors - this will raise an error if status is not VI_SUCCESS
CALL CheckError(vi, status)

'adjust string length
Response = Left(Response, retCount)

End Sub
```

The following function illustrates status/error checking. The procedure raises an exception, when a VISA error occurs:

```
Public Sub CheckError(ByVal vi As Long, status As Long)
Dim ErrorMessage As String * 1024

'Initialize error message string
ErrorMessage = ""
If (status < 0) Then
    'Query the error message from VISA
    If (viStatusDesc(vi, status, ErrorMessage) = VI_SUCCESS) Then
        Err.Description = ErrorMessage
    End If
    Err.Raise (status)
End If

End Sub
```

Initialization and Default State

At the start of each program, the global variables used by all subroutines must be created. The remote control and the instrument settings will then be changed to a defined default state. The two subroutines "InitController" and "InitDevice" are used for this purpose.

Creating Global Variables

In Visual Basic, global variables are stored in modules (data extension .BAS). Thus, at least one module (e.g. GLOBALS.BAS) must be created that contains the variable used by all subroutines, e.g. the variables for device addresses used by the remote control driver. For all example programs shown below, the file must contain the following instructions:

```
Global analyzer As Long
Global defaultRM As Long
```

Initializing the Remote Control Session

```
REM ----- Initializing the remote control session -----
Public SUB Initialize()
    Dim status As Long

    'CALL viOpenDefaultRM to get the resource manager handle
    'Store this handle in defaultRM. The function viStatusDesc
    'returns a text description of the status code returned by viOpenDefaultRM

    status = viOpenDefaultRM(defaultRM)
    status = viStatusDesc(defaultRM, status, Response)

    'Open the connection to the device and store the handle
    'Note: The timeout value in viOpen() applies only for opening the interface
    'For setting the communication timeout, set the VI_ATTR_TMO_VALUE attribute
    'timeout values are in milliseconds
    'This example assumes the instrument IP address 10.0.0.10
    'If the network provides a name resolution mechanism, the hostname of
    'the instrument can be used instead of the numeric IP address
    'the resource string for GPIB would be "GPIB::20::INSTR"
    status = viOpen(defaultRM, "TCPIP::10.0.0.10::INSTR", 0, 1000, analyzer)
    'status = viOpen(defaultRM, "TCPIP::<hostname>::INSTR", 0, 1000, analyzer)
    'status = viOpen(defaultRM, "GPIB::20::INSTR", 0, 1000, analyzer)

    'Set timeout value - here 5s
    status = viSetAttribute(vi, VI_ATTR_TMO_VALUE, 5000)

END SUB
REM *****
```

Initializing the Instrument

Set the remote control status registers and instrument settings to the default state.

```

REM ----- Initializing the instrument -----
Public SUB InitDevice()

CALL InstrWrite(analyzer, "*CLS")      'Reset status register
CALL InstrWrite(analyzer, "*RST")     'Reset instrument

END SUB
REM*****

```

Switching the Screen Display On and Off

In the default setting, all remote control commands are carried out with the screen display switched off in order to attain optimum measurement speed. During the development phase of remote control programs, however, the screen display is required in order to visually check both the programming of the settings and the measurement results.

The following examples show functions with which the screen display can be switched on or off during remote control operation.

```

REM ----- Switching on the screen display -----
Public SUB DisplayOn()

CALL InstrWrite(analyzer, "SYST:DISP:UPD ON")
                                'Switch on screen display

END SUB
REM*****

```

```

REM ----- Switching off the screen display -----
Public SUB DisplayOff()

CALL InstrWrite(analyzer, "SYST:DISP:UPD OFF")
                                'Switch off screen display

END SUB
REM*****

```

Configuring the Power Save Function for the Display

During remote control operation, it is often unnecessary to display the measurement results on screen. Although the command `SYSTem:DISPlay:UPDate OFF` switches off the display of the measurement results, thus significantly improving speed in remote control operation, the display itself and the background lighting in particular remain switched on.

If you also want to switch off the display itself, you must use the power save function by setting the response time in minutes prior to activation.

Note: *The display will be immediately reactivated if you press a key on the instrument's front panel.*

```
Public SUB PowerSave()
```

```
CALL InstrWrite(analyzer, "DISPlay:PSAVe:HOLDoff 1")
                                'Set response time to 1 minute
CALL InstrWrite(analyzer, "DISPlay:PSAVe ON")
                                'Switch on Power Save function
```

Sending Simple Instrument Setting Commands

This example shows how the center frequency, span and reference level of the instrument are set.

```
REM ----- Instrument setting commands -----
PUBLIC SUB SimpleSettings()

CALL InstrWrite(analyzer, "FREQUENCY:CENTER 128MHz")
                                'Center frequency 128 MHz
CALL InstrWrite(analyzer, "FREQUENCY:SPAN 10MHZ")
                                'Set span to 10 MHz
CALL InstrWrite(analyzer, "DISPLAY:TRACE:Y:RLEVEL -10dBm")
                                'Set reference level to -10dBm

END SUB
REM *****
```

Switching to Manual Operation

```
REM ----- Switching instrument to manual operation -----
CALL viGpibControlREN(analyzer, VI_GPIB_REN_ADDRESS_GTL)
                                'Set instrument to Local state
REM *****
```

Reading Out Instrument Settings

The settings made above can now be read out. To do so, the abbreviated commands are used.

```

REM ----- Reading out instrument settings -----
PUBLIC SUB ReadSettings()
Dim retCount as Long

CFfrequency$ = SPACE$(20)           'Provide text variable (20 characters)
CALL InstrWrite(analyzer, "FREQ:CENT?")
                                   'Request center frequency
CALL InstrRead(analyzer, CFfrequency$, 20, retCount)
                                   'Read value
CFspan$ = SPACE$(20)                'Provide text variable (20 characters)
CALL InstrWrite(analyzer, "FREQ:SPAN?")
                                   'Request span
CALL InstrRead(analyzer, CFspan$, 20, retCount)
                                   'Read value

RLlevel$ = SPACE$(20)               'Provide text variable (20 characters)
CALL InstrWrite(analyzer, "DISP:TRAC:Y:RLEV?")
                                   'Request ref level setting
CALL InstrRead(analyzer, RLlevel$, 20, retCount)
                                   'Read value

REM ----- Displaying values in the Immediate window -----
Debug.Print "Center frequency: "; CFfrequency$,
Debug.Print "Span:           "; CFspan$,
Debug.Print "Reference level: "; RLlevel$,

END SUB
REM*****

```

Marker Positioning and Readout

```

REM ----- Example of marker function -----
PUBLIC SUB ReadMarker()
Dim retCount as Long

CALL InstrWrite(analyzer, "CALC:MARKER ON;MARKER:MAX")
                                   'Activate marker 1 and search for peak
MKmark$ = SPACE$(30)              'Provide text variable (30 characters)
CALL InstrWrite(analyzer, "CALC:MARK:X?;Y?")
                                   'Query frequency and level
CALL InstrRead(analyzer, MKmark$, 30, retCount)
                                   'Read value

REM ----- Displaying values in the Immediate window -----
Debug.Print "Marker frequency/level "; MKmark$,

END SUB
REM *****

```

Command Synchronization

The synchronization methods used in the following example are described in the Operating Manual on CD, chapter 4 "Remote Control – Basics", section "Command Sequence and Command Synchronization".

```

REM ----- Commands for command synchronization -----
PUBLIC SUB SweepSync()
Dim retCount as Long
Dim SRQWaitTimeout As Long
Dim eventType As Long
Dim eventVi As Long
REM The command INITiate[:IMMEDIATE] starts a single sweep if the
REM command INIT:CONT OFF has already been sent. The next command
REM must not be carried out until a full sweep has been completed.
CALL InstrWrite(analyzer, "INIT:CONT OFF")

REM ----- First method: Using *WAI -----
CALL InstrWrite(analyzer, "ABOR;INIT:IMM; *WAI")

REM ----- Second method: Using *OPC? -----
OpcOk$ = SPACE$(2) 'Provide space for *OPC? response
CALL InstrWrite(analyzer, "ABOR;INIT:IMM; *OPC?")

REM ----- In this case, the controller can use other instruments -----
CALL InstrRead(analyzer, OpcOk$, 2, retCount)
'Wait for "1" from *OPC?

REM ----- Third method: Using *OPC -----
REM In order for the Service Request function to be used with a GPIB
REM driver from National Instruments, the setting "Disable
REM Auto Serial Poll" must be set to "yes" with IBCONF!
CALL InstrWrite(analyzer, "*SRE 32") 'Enable Service Request for ESR
CALL InstrWrite(analyzer, "*ESE 1") 'Set event enable bit for operation
'complete bit
CALL viEnableEvent(vi, VI_EVENT_SERVICE_REQ, VI_QUEUE, 0)
'Enable the event for service request
CALL InstrWrite(analyzer, "ABOR;INIT:IMM; *OPC")
'Start sweep with Synchronization to OPC
SRQWaitTimeout = 5000 'Allow 5s for sweep completion
'Now wait for the service request
CALL viWaitOnEvent(vi, VI_EVENT_SERVICE_REQ, SRQWaitTimeout, eventType, eventVi)
CALL viClose(eventVi) 'Close the context before continuing
CALL viDisableEvent(vi, VI_EVENT_SERVICE_REQ, VI_QUEUE)
'Disable subsequent events

REM Resume main program here.

END SUB
REM *****

```

Reading Output Buffers

```

REM ----- Subroutine for the individual STB bits -----
Public SUB Outputqueue()                'Reading the output queue
Dim retCount as Long

result$ = SPACE$(100)                  'Create space for response
CALL InstrRead(analyzer, result$, 100, retCount)
Debug.Print "Contents of Output Queue : "; result$

END SUB
REM *****

```

Reading Error Messages

```

REM ----- Subroutine for evaluating the error queue -----
Public SUB ErrorQueueHandler()
Dim retCount as Long

ERROR$ = SPACE$(100)                  Subroutine for evaluating the error queue
CALL InstrWrite(analyzer, "SYSTEM:ERROR?")
CALL InstrRead(analyzer, ERROR$, 100, retCount)
Debug.Print "Error Description : "; ERROR$

END SUB
REM *****

```

Detailed Programming Examples

In the following sections typical programming examples for setting measurement parameters and functions, general settings, printout and data management are provided.

Default Setting of the R&S ESL

The following settings provide typical examples of how to change the default setting of the R&S ESL.

Note that only some of the settings are necessary depending on the application example. In many cases, it is not necessary to set resolution bandwidth, video bandwidth and sweep time since these parameters are automatically calculated in the default setting when the span is changed. Likewise, the input attenuation is automatically calculated in the default setting as a function of the reference level. Last of all, the level detectors are linked to the selected trace mode in the default setting.

The settings automatically calculated in the default setting are indicated with an asterisk (*) in the following program example.

Setting the Remote Control Status Registers

```

REM *****
Public Sub SetupStatusReg()

'----- IEEE 488.2 status register -----
CALL InstrWrite(analyzer,"*CLS")      'Reset status registers
CALL InstrWrite(analyzer,"*SRE 168")  'Enable Service Request for
                                       'STAT:OPER-,STAT:QUES- and ESR-Register
CALL InstrWrite(analyzer,"*ESE 61")   'Set event enable bit for:
                                       'operation complete 'command-, execution-,
                                       'device dependent- and query error

'----- SCPI status register -----
CALL InstrWrite(analyzer,"STAT:OPER:ENAB 0")
                                       'Disable OPERation Status reg
CALL InstrWrite(analyzer,"STAT:QUES:ENAB 0")
                                       'Disable questionable Statusreg

End Sub
REM *****

```

Default Settings for Measurements

```

REM *****
Public Sub SetupInstrument()

'----- Default setting of the R&S ESL -----
CALL SetupStatusReg                  'Configure status registers
CALL InstrWrite(analyzer,"*RST")     'Reset instrument
CALL InstrWrite(analyzer,"SYST:DISP:UPD ON")
                                       'ON: screen display on
                                       'OFF: off (improved performance)
CALL InstrWrite(analyzer,"DISP:FORM SINGLE")
                                       'Full screen display
CALL InstrWrite(analyzer,"DISP:WIND1:SEL")
                                       'Active Screen A
CALL InstrWrite(analyzer,"INIT:CONT OFF")
                                       'Single sweep mode

'----- Frequency setting -----
CALL InstrWrite(analyzer,"FREQUENCY:CENTER 100MHz")
                                       'Center frequency
CALL InstrWrite(analyzer,"FREQ:SPAN 1 MHz")
                                       'Span

'----- Level setting -----
CALL InstrWrite(analyzer,"DISP:WIND:TRAC:Y:RLEV -20dBm")
                                       'Reference level
CALL InstrWrite(analyzer,"INP:ATT 10dB")
                                       'Input attenuation  (*)

```

```

'----- Level scaling -----
CALL InstrWrite(analyzer,"DISP:WIND:TRAC:Y:SPAC LOG")
                        'Log level axis
CALL InstrWrite(analyzer,"DISP:WIND:TRAC:Y:SCAL 100dB")
                        'Level range
CALL InstrWrite(analyzer,"DISP:WIND:TRAC:Y:SCAL:MODE ABS")
                        'Absolute scaling
CALL InstrWrite(analyzer,"CALC:UNIT:POW DBM")
                        'y meas. unit

'----- Trace and detector setting -----
CALL InstrWrite(analyzer,"DISP:TRAC1:MODE AVER")
                        'Trace1 average
CALL InstrWrite(analyzer,"AVER:TYPE VID")
                        'Average mode video; "LIN" for linear
CALL InstrWrite(analyzer,"SWE:COUN 10")
                        'Sweep count
CALL InstrWrite(analyzer,"DISP:TRAC2 OFF")
                        'Trace2 blank
CALL InstrWrite(analyzer,"DISP:TRAC3 OFF")
                        'Trace3 blank
CALL InstrWrite(analyzer,"DISP:TRAC4 OFF")
                        'Trace4 blank
CALL InstrWrite(analyzer,"DISP:TRAC5 OFF")
                        'Trace5 blank
CALL InstrWrite(analyzer,"DISP:TRAC6 OFF")
                        'Trace6 blank
CALL InstrWrite(analyzer,"CALC:MATH:STAT OFF")
                        'Trace difference off
CALL InstrWrite(analyzer,"DET1 RMS")
                        'Detector Trace1      (*)
CALL InstrWrite(analyzer,"DET2:AUTO ON")
                        'Detector Trace2      (*)
CALL InstrWrite(analyzer,"DET3:AUTO ON")
                        'Detector Trace3      (*)
CALL InstrWrite(analyzer,"DET4:AUTO ON")
                        'Detector Trace4      (*)
CALL InstrWrite(analyzer,"DET5:AUTO ON")
                        'Detector Trace5      (*)
CALL InstrWrite(analyzer,"DET6:AUTO ON")
                        'Detector Trace6      (*)

'----- Bandwidths and sweep time -----
CALL InstrWrite(analyzer,"BAND:RES 100KHz")
                        'Resolution bandwidth (*)
CALL InstrWrite(analyzer,"BAND:VID 1MHz")
                        'Video bandwidth      (*)
CALL InstrWrite(analyzer,"SWE:TIME 100ms")
                        'Sweep time          (*)

END SUB
REM *****

```

Using Markers and Delta Markers

The markers are used for marking points on traces, reading out measurement results and for quickly selecting a display section.

Marker Search Functions, Restricting the Search Range

The following example is based on an AM-modulated signal at 100 MHz that has the following characteristics:

- Carrier signal level: -30 dBm
- AF frequency: 100 kHz
- Modulation depth: 50 %

Marker 1 and then delta marker 2 are set to the largest maximum points on the trace. The frequency and level are then read. In the following measurements, the instrument's default setting can be used for measurements (SetupInstrument).

```

REM *****
Public Sub MarkerSearch()
Dim retCount as Long

result$ = Space$(100)
CALL SetupInstrument           'Default Setting
'----- Peak search without search range limits-----
CALL InstrWrite(analyzer,"INIT:CONT OFF")
                                'Switch to single sweep
CALL InstrWrite(analyzer,"CALC:MARK:PEXC 6DB")
                                'Define peak excursion
CALL InstrWrite(analyzer,"CALC:MARK:STAT ON")
                                'Enable marker 1
CALL InstrWrite(analyzer,"CALC:MARK:TRAC 1")
                                'Set marker 1 to trace 1
CALL InstrWrite(analyzer,"INIT;*WAI") 'Perform sweep with sync
CALL InstrWrite(analyzer,"CALC:MARK:MAX;X?;Y?")
                                'Marker to peak; read frequency and level
CALL InstrRead(analyzer, result$, 100, retCount)
Debug.Print "Marker 1: ";result$
CALL InstrWrite(analyzer,"CALC:DELT2:STAT ON;MAX;MAX:LEFT")
                                'Activate delta marker 2,
                                'set to peak and then to next peak left
CALL InstrWrite(analyzer,"CALC:DELT2:X?;Y?")
                                'Read delta marker 2 frequency and level

result$ = Space$(100)
CALL InstrRead(analyzer, result$, 100, retCount)
Debug.Print "Delta 2: ";result$

```

```

'----- Peak search with search range limit in x direction -----
CALL InstrWrite(analyzer,"CALC:MARK:X:SLIM:STAT ON;LEFT 0Hz;RIGHT 100.05MHz")
      'Activate search limit,
      'set at right below AF
CALL InstrWrite(analyzer,"CALC:DELT3:STAT ON;MAX;MAX:RIGHT")
      'Activate delta marker 3,
      'set to peak and then to next peak right
CALL InstrWrite(analyzer,"CALC:DELT3:X:REL?;:CALC:DELT3:Y?")
      'Read delta marker 3 frequency and level;
      'both must have a value of 0

result$ = Space$(100)
CALL InstrRead(analyzer, result$, 100, retCount)
Print "Delta 3: ";result$
'----- Peak search with search range limit in y direction -----
CALL InstrWrite(analyzer,"CALC:THR:STAT ON")
CALL InstrWrite(analyzer,"CALC:THR -35DBM")
      'Activate threshold and set it above the AF
CALL InstrWrite(analyzer,"CALC:DELT3:STAT ON;MAX;MAX:NEXT")
      'Activate delta marker 3,
      'set to peak and then to next peak
      '=> is not found
CALL InstrWrite(analyzer,"CALC:DELT3:X:REL?;:CALC:DELT3:Y?")
      'Query and read delta marker 3
      'frequency and level;
      'both must have a value of 0

result$ = Space$(100)
CALL InstrRead(analyzer, result$, 100, retCount)
Debug.Print "Delta 3: ";result$

'---- Setting center frequency and reference level with markers -----
CALL InstrWrite(analyzer,"CALC:MARK2:FUNC:CENT")
      'Delta marker 2 -> marker and
      'center frequency = marker 2
CALL InstrWrite(analyzer,"CALC:MARK2:FUNC:REF")
      'Ref level = marker 2
CALL InstrWrite(analyzer,"INIT;*WAI") 'Sweep with sync

END SUB
REM *****

```

Frequency Counting

The following example is based on a signal at 100 MHz with a level of –30 dBm. Also in this measurement, the instrument's default setting can be used (SetupInstrument). The purpose of frequency counting is to determine the exact frequency of the signal at 100 MHz.

```

REM *****
Public Sub MarkerCount()
Dim retCount as Long

CALL SetupInstrument           'Default setting
'<----- Defining signal frequency with frequency counter -----
CALL InstrWrite(analyzer,"INIT:CONT OFF")
                               'Switch to single sweep
CALL InstrWrite(analyzer,"CALC:MARK:PEXC 6DB")
                               'Define peak excursion
CALL InstrWrite(analyzer,"CALC:MARK:STAT ON")
                               'Activate marker 1
CALL InstrWrite(analyzer,"CALC:MARK:TRAC 1")
                               'Set marker 1 to trace 1
CALL InstrWrite(analyzer,"CALC:MARK:X 100MHz")
                               'Set marker 1 to 100 MHz
CALL InstrWrite(analyzer,"CALC:MARK:COUNT:RES 1HZ")
                               'Set count resolution to 1 Hz
CALL InstrWrite(analyzer,"CALC:MARK:COUNT ON")
                               'Activate frequency counter
CALL InstrWrite(analyzer,"INIT;*WAI") 'Perform sweep with sync
CALL InstrWrite(analyzer,"CALC:MARK:COUNT:FREQ?")
                               'Query and read measured frequency

result$ = Space$(100)
CALL InstrRead(analyzer, result$, 100, retCount)
Debug.Print "Marker Count Freq: ";result$

END SUB
REM *****

```

Working with a Fixed Reference Point

The following example is based on a signal at 100 MHz with a level of –20 dBm. Thus, the harmonics of the signal are located at 200 MHz, 300 MHz, etc. In the case of high-quality signal sources, these harmonics may be located outside the dynamic range of the R&S ESL. Nevertheless, to measure the harmonic suppression, the level setting must be changed to higher sensitivity when measuring the harmonics, in which case it may be necessary to suppress the carrier by using a notch filter in order to prevent the RF input of the R&S ESL from being overloaded.

Thus, two measurements with different level settings are performed in the following example. First, a high reference level is used on the carrier frequency, and then a low reference level is used on the frequency of the third harmonic.

The default setting of the R&S ESL for measurements (SetupInstrument) is also used as a starting point here, after which adaptations for the measurement are carried out.

```

REM *****
Public Sub RefFixed()
Dim retCount as Long

CALL SetupInstrument          'Default setting
'----- Measuring the reference point -----
CALL InstrWrite(analyzer,"INIT:CONT OFF")
                                'Switch to single sweep
CALL InstrWrite(analyzer,"CALC:MARK:PEXC 6DB")
                                'Define peak excursion
CALL InstrWrite(analyzer,"CALC:MARK:STAT ON")
                                'Activate marker 1
CALL InstrWrite(analyzer,"CALC:MARK:TRAC 1")
                                'Set marker 1 to trace 1
CALL InstrWrite(analyzer,"INIT;*WAI") 'Perform sweep with sync
CALL InstrWrite(analyzer,"CALC:MARK:MAX")
                                'Set marker 1 to 100 MHz
CALL InstrWrite(analyzer,"CALC:DELT:FUNC:FIX ON")
                                'Define reference point
'----- Setting frequency, level and bandwidth for measuring harmonics -----
CALL InstrWrite(analyzer,"FREQ:CENT 400MHz;Span 1MHz")
                                'Set freq of 3rd harmonic
CALL InstrWrite(analyzer,"BAND:RES 1kHz")
                                'Set suitable RBW
CALL InstrWrite(analyzer,"SWEEP:TIME:AUTO ON")
                                'Couple sweep time
CALL InstrWrite(analyzer,"INP:ATT:AUTO ON")
                                'Select more sensitive level setting
CALL InstrWrite(analyzer,"DISP:WIND:TRAC:Y:RLEV -50dBm")
CALL InstrWrite(analyzer,"INIT;*WAI") 'Perform sweep with sync
CALL InstrWrite(analyzer,"CALC:DELT:MAX;X:REL?;Y?")
                                'Read delta marker
result$ = Space$(100)
CALL InstrRead(analyzer, result$, 100, retCount)
                                'Read frequency and level
Debug.Print "Deltamarker 1: "; result$

END SUB
REM *****

```

Measuring Noise and Phase Noise

When phase noise is measured, the noise power related to a bandwidth of 1 Hz is set in relation to the power of an adjacent carrier signal. A commonly used offset between the measured frequency and the carrier frequency is 10 kHz.

When noise is measured, the measured absolute level is related to a bandwidth of 1 Hz.

The following example is also based on a signal at 100 MHz with a level of -30 dBm. Two markers are used to determine both the noise and the phase noise at a 10 kHz offset from the carrier signal.

```

REM *****
Public Sub Noise()
Dim retCount as Long

'----- Default setting of the R&S ESL -----
CALL SetupStatusReg           'Configure status register
CALL InstrWrite(analyzer,"*RST") 'Reset instrument
CALL InstrWrite(analyzer,"INIT:CONT OFF")
                                   'Single sweep mode

'----- Setting the frequency -----
CALL InstrWrite(analyzer,"FREQUENCY:CENTER 100MHz")
                                   'Center frequency
CALL InstrWrite(analyzer,"FREQ:SPAN 100 kHz")
                                   'Span

'----- Setting the level -----
CALL InstrWrite(analyzer,"DISP:WIND:TRAC:Y:RLEV -20dBm")
                                   'Reference level
CALL InstrWrite(analyzer,"INIT;*WAI") 'Perform sweep with sync

'----- Setting the reference point -----
CALL InstrWrite(analyzer,"CALC:MARK:PEXC 6DB")
                                   'Define peak excursion
CALL InstrWrite(analyzer,"CALC:MARK:STAT ON")
                                   'Activate marker 1
CALL InstrWrite(analyzer,"CALC:MARK:TRAC 1")
                                   'Set marker 1 to trace 1
CALL InstrWrite(analyzer,"CALC:MARK:MAX")
                                   'Set marker 1 to 100 MHz
CALL InstrWrite(analyzer,"CALC:DELT:FUNC:PNO ON")
                                   'Define reference point for phase noise

'----- Measuring the phase noise -----
CALL InstrWrite(analyzer,"CALC:DELT:X 10kHz")
                                   'Position delta marker
CALL InstrWrite(analyzer,"CALC:DELT:FUNC:PNO:RES?")
                                   'Query and output phase noise result

result$ = Space$(100)
CALL InstrRead(analyzer, result$, 100, retCount)
Debug.Print "Phase Noise [dBc/Hz]: "; result$

'----- Measuring the noise -----
CALL InstrWrite(analyzer,"CALC:MARK:X 99.96MHz")
                                   'Position marker 1
CALL InstrWrite(analyzer,"CALC:MARK:FUNC:NOIS:RES?")
                                   'Query and output result

result$ = Space$(100)
CALL InstrRead(analyzer, result$, 100, retCount)
Print "Noise [dBm/Hz]: "; result$

END SUB
REM *****

```

Reading Out Trace Data

In the following example, the trace data obtained with the default setting is read from the instrument and displayed in a list on screen. Readout occurs first in binary format and then in ASCII format, once with the span > 0 and once with the span = 0.

In binary format, the header of the message with the length specification is evaluated and used to calculate the x axis values.

In ASCII format, merely the list of level values is output.

Binary data is read out in three steps:

1. The number of digits in the length specification is read out.
2. The length specification itself is read out.
3. The trace data itself is read out.

The procedure is required in the case of programming languages that only support structures with data types of the same type (arrays) (such as with Visual Basic), because the data types of the header and data sections are different in binary data.

The VISA library provides only a mechanism for reading into string buffers. In order to convert the data into an array of single precision values, the string contents must be copied into a buffer of that type. The following example uses an operating system function for the copy operation. The function declaration must be added to a module (.bas) as follows:

```
Private Declare Sub CopyMemory Lib "kernel32" Alias "RtlMoveMemory" (pDest As Any, pSource As Any, ByVal ByteLen As Long)
```

Note: *The arrays for the measured data are dimensioned in such a way that they provide sufficient space for trace data of the R&S ESL (501 measurement points).*

```
REM *****
Public Sub ReadTrace()

'----- Creating variables -----
Dim traceData(1250) As Single      'Buffer for floating point binary data
Dim digits As Byte                 'Number of characters in
                                  'length specification
Dim traceBytes As Integer          'Len. of trace data in bytes
Dim traceValues As Integer         'No. of meas. values in buff.
Dim BinBuffer as String * 5000    'String buffer for binary data
Dim retCount as Long

asciiResult$ = Space$(25000)      'Buffer for ASCII trace data
result$ = Space$(100)             'Buffer for simple results
startFreq$ = Space$(100)         'Buffer for start frequency
span$ = Space$(100)              'Buffer for span

'----- Default setting of the R&S ESL -----
CALL SetupInstrument              'Default setting
CALL InstrWrite(analyzer,"INIT:CONT OFF")
                                  'Switch to single sweep
CALL InstrWrite(analyzer,"INIT;*WAI") 'Perform sweep with sync
```



```

'----- Defining the frequency range for output -----
CALL InstrWrite(analyzer,"FREQ:START?") 'Read start frequency
CALL InstrRead(analyzer,startFreq$, 100, retCount)
startFreq = Val(startFreq$)
CALL InstrWrite(analyzer,"FREQ:SPAN?") 'Read span
CALL InstrRead(analyzer,span$, 100, retCount)
span = Val(span$)
'----- Reading out in binary format -----
CALL InstrWrite(analyzer, "FORMAT REAL,32")
                                'Set binary format
CALL InstrWrite(analyzer, "TRAC1? TRACE1")
                                'Read trace 1
CALL InstrRead(analyzer, result$, 2, retCount)
                                'Read and store length
digits = Val(Mid$(result$, 2, 1)) 'spec. for number of characters
result$ = Space$(100)           'Reinitialize buffer
CALL InstrRead(analyzer, result$, digits, retCount)
                                'Read and store length
traceBytes = Val(Left$(result$, digits))
                                'specification
CALL InstrRead(analyzer, BinBuffer, traceBytes, retCount)
                                'Read trace data into buffer
CopyMemory traceData(0), ByVal BinBuffer, traceBytes
                                'Copy data into float array
'----- Outputting binary data as frequency/level pairs -----
traceValues = traceBytes/4      'Single precision = 4 bytes
stepsize = span/traceValues    'Calculate frequency step size
For i = 0 To traceValues - 1
Debug.Print "Value["; i; "] = "; startFreq+stepsize*i; ", "; traceData(i)
Next i
'----- Default setting of zero span -----
CALL InstrWrite(analyzer,"FREQ:SPAN 0Hz")
                                'Switch to zero span
CALL InstrWrite(analyzer,"INIT;*WAI") 'Perform sweep with sync
'----- Reading out in ASCII format -----
CALL InstrWrite(analyzer,"FORMAT ASCII")
                                'Set ASCII format
CALL InstrWrite(analyzer,"TRAC1? TRACE1")
                                'Read and output
CALL InstrRead(analyzer, asciiResult$)
Print "Contents of Trace1: ",asciiResult$ 'trace 1

END SUB
REM *****

```

Storing and Loading Instrument Settings

Settings and measured data can be stored and loaded. The data set that is loaded when the instrument is preset or started, can be set.

Storing Instrument Settings

In the following example, the settings/measured data to be stored are initially defined, in which case only the hardware settings are stored. However, the selection commands for the other settings are specified with the state "OFF" for the sake of completeness.

```

REM *****
Public Sub StoreSettings()

'----- Default settings of the R&S ESL -----
'This subroutine selects the settings to be stored and creates the
'data record "TEST1" in the directory C:\R_S\Instr\user. It uses the default
'setting and resets the instrument after the setting is stored.
CALL SetupInstrument
CALL InstrWrite(analyzer,"INIT:CONT OFF")
                                'Change to single sweep
CALL InstrWrite(analyzer,"INIT;*WAI") 'Perform sweep with sync
'----- Selection of settings to be stored -----
CALL InstrWrite(analyzer,"MMEM:SEL:HWS ON")
                                'Store hardware settings
CALL InstrWrite(analyzer,"MMEM:SEL:TRAC OFF")
                                'Do not store any traces
CALL InstrWrite(analyzer,"MMEM:SEL:LIN:ALL OFF")
                                'Store only the activated limit lines
'----- Storing on the instrument -----
CALL InstrWrite(analyzer,"MMEM:STOR:STAT 1,'C:\R_S\Instr\user\TEST1'")
'----- Resetting the instrument -----
CALL InstrWrite(analyzer,"*RST")

END SUB
REM *****

```

Loading Instrument Settings

In the following example, the TEST1 data record stored under C:\R_S\Instr\user is loaded by the instrument:

```

REM *****
Public Sub LoadSettings()

'----- Default setting of the status register -----
'This subroutine loads the TEST1 data record in the directory
'C:\R_S\Instr\user.
CALL SetupStatusReg
                                'Configure status register
'----- Loading the data record -----
CALL InstrWrite(analyzer,"MMEM:LOAD:STAT 1,'C:\R_S\Instr\user\TEST1'")
'----- Perform measurement using loaded data record -----
CALL InstrWrite(analyzer,"DISP:TRAC1:MODE WRIT")
                                'Set trace to Clr/Write
CALL InstrWrite(analyzer,"INIT;*WAI") 'Start sweep

END SUB
REM *****

```

Setting the Data Record for Startup Recall

In the following example, the first step is to change the R&S ESL to the default state. In the next step, the TEST1 data record stored under C:\R_S\Instr\user is selected for the startup recall function, i.e. the data record is then set after each *RST, preset and each time the instrument is started. For demonstration purposes, the command *RST is carried out again.

```

REM *****
Public Sub StartupRecallSettings()

'----- Resetting the R&S ESL -----
CALL InstrWrite(analyzer,"*RST")
'----- Default setting of the status register -----
CALL SetupStatusReg           'Configure status register
'----- Selecting the startup recall data record -----
CALL InstrWrite(analyzer,"MMEM:LOAD:AUTO 1,'C:\R_S\Instr\user\TEST1'")
'----- Activating the startup recall data record -----
CALL InstrWrite(analyzer,"*RST")

END SUB
REM *****

```

Configuring and Starting a Printout

The following example shows how to configure the output format and output device for printing out a measurement screen. The procedure is as follows:

1. Set the measurement you want for the printout.
2. Check which output devices are available on the instrument.
3. Select an output device.
4. Select the output interface.
5. Configure the output format.
6. Start the printout with synchronization to completion.

It is assumed that the desired setting is a signal at 100 MHz with a power of -20 dBm. It is also assumed that the sixth printer out of the available printers that are listed is the one you want. The printout is first output to the selected printer and then to a file.

```

REM *****
Public Sub HCopy()
Dim retCount as Long
Dim SRQWaitTimeout As Long
Dim eventType As Long
Dim eventVi As Long
Dim statusSRQ As Long
DIM Devices(100) as string           'Create buffer for printer name
FOR i = 0 TO 49
    Devices$(i) = Space$(50)        'Preallocate buffer for printer name
NEXT i

```

```

'----- Default setting of the R&S ESL -----
CALL SetupStatusReg           'Configure status register
CALL InstrWrite(analyzer,"*RST") 'Reset instrument
CALL InstrWrite(analyzer,"INIT:CONT OFF")
                                   'Single sweep mode
CALL InstrWrite(analyzer,"SYST:DISP:UPD ON")
                                   'Screen display on

'----- Measurement settings -----
CALL InstrWrite(analyzer,"FREQ:CENT 100MHz;SPAN 10MHz")
                                   'Frequency setting
CALL InstrWrite(analyzer,"DISP:TRAC:Y:RLEV -10dBm")
                                   'Reference level
CALL InstrWrite(analyzer,"INIT;*WAI") 'Perform measurement

'----- Querying the available output devices -----
CALL InstrWrite(analyzer,"SYST:COMM:PRIN:ENUM:FIRSt?")
                                   'Read out and display first output device
CALL InstrRead(analyzer,Devices$(0), 50, retCount)
Debug.Print "Printer 0: "+Devices$(0)
For i = 1 to 99
    CALL InstrWrite(analyzer,"SYST:COMM:PRIN:ENUM:NEXT?")
                                   'Read out next printer name
    CALL InstrRead(analyzer,Devices$(i))
    IF Left$(Devices$(i),2) = "" THEN GOTO SelectDevice
                                   'Stop at end of list
    Debug.Print "Printer"+Str$(i)+" : " Devices$(i)
                                   'Display printer name
NEXT i
SelectDevice:
'---- Selection of output device, printer language and output interface ----
CALL InstrWrite(analyzer,"SYST:COMM:PRIN:SEL "+ Devices(6))
                                   'Printer selection #6
CALL InstrWrite(analyzer,"HCOP:DEST 'SYST:COMM:PRIN'")
                                   'Configuration: "Printout to
                                   'printer interface"
CALL InstrWrite(analyzer,"HCOP:DEV:LANG GDI")
                                   'Printers require printer language 'GDI'

'---- Selection of orientation (portrait/landscape) and colour/BW -----
CALL InstrWrite(analyzer,"HCOP:PAGE:ORI PORT")
                                   'Portrait orientation
CALL InstrWrite(analyzer,"HCOP:DEV:COL OFF")
                                   'Black-and-white printout

'---- Configuring and starting the printout -----
CALL InstrWrite(analyzer,"HCOP:ITEM:ALL")
                                   'All screen contents
'CALL InstrWrite(analyzer,"HCOP:ITEM:TRAC:STAT ON")
                                   'Alternative: only traces
CALL InstrWrite(analyzer,"*CLS") 'Reset status registers
CALL viEnableEvent(vi, VI_EVENT_SERVICE_REQ, VI_QUEUE, 0)
                                   'Enable the event for service request
CALL InstrWrite(analyzer,"HCOP;*OPC")
                                   'Start printout
SRQWaitTimeout = 5000
                                   'Allow 5s for completion
                                   'Now wait for the service request
statusSRQ = viWaitOnEvent(vi, VI_EVENT_SERVICE_REQ, SRQWaitTimeout, eventType,
eventVi)
CALL viClose(eventVi)
                                   'Close the context before continuing

```

```

CALL viDisableEvent(vi, VI_EVENT_SERVICE_REQ, VI_QUEUE)
                                'Disable subsequent events
IF NOT(statusSRQ = 0) THEN CALL Srq 'If SRQ not detected =>
                                'Subroutine for evaluation
'---- Printout in WMF format (BMP format) to file -----
CALL InstrWrite(analyzer,"HCOP:DEST 'MMEM'")
                                'Configuration: "Printout to file"
CALL InstrWrite(analyzer,"HCOP:DEV:LANG WMF")
                                'WMF file format
'CALL InstrWrite(analyzer,"HCOP:DEV:LANG BMP")
                                'BMP file format
CALL InstrWrite(analyzer,"MMEM:NAME 'C:\R_S\Instr\user\PRINT1.WMF'")
                                'Define file name
CALL InstrWrite(analyzer,"*CLS") 'Reset Status registers
CALL viEnableEvent(vi, VI_EVENT_SERVICE_REQ, VI_QUEUE, 0)
                                'Enable the event for service request
CALL InstrWrite(analyzer,"HCOP:IMMEDIATE;*OPC")
                                'Start printout
SRQWaitTimeout = 5000          'Allow 5s for completion
                                ' Now wait for the service request
statusSRQ = viWaitOnEvent(vi, VI_EVENT_SERVICE_REQ, SRQWaitTimeout, eventType,
eventVi)
CALL viClose(eventVi)          'Close the context before continuing
CALL viDisableEvent(vi, VI_EVENT_SERVICE_REQ, VI_QUEUE)
                                'Disable subsequent events
IF NOT(statusSRQ = 0) THEN CALL Srq 'If SRQ not detected =>
                                'Subroutine for evaluation

END SUB
REM *****

```

Appendix A: Printer Interface

For printout local USB printers or network printers can be used. In this appendix, the installation of local printers is described. Network printer installation is described in section "To install a network printer" in Appendix B, LAN Interface.

Note: *The following step-by-step instructions describe the process via a mouse and an external keyboard. It is also possible to install local printers using the front panel of the instrument. For details on the operation via the front panel refer to chapter 4 "Basic Operations".*

After installation the instrument must be configured for printout with a printer. How to select and configure printers is described in chapter 2 "Preparing for Use", section "R&S ESL Setup".

Installing Local Printers

As a local printer, only USB printers can be connected. For details on connectors see chapter 1 "Front and Rear Panel".

Note: *When you install printer drivers that are not preinstalled on the computer, you can use one of the following external devices: LAN, USB device (memory stick or CD-ROM).*

You can install a local printer via manual or remote control. In the following step-by-step instructions, the installation process is described via Remote Desktop. Alternatively, you can connect a mouse and an external keyboard for the installation instead of using the R&S ESL front panel (for details see chapter 2 "Preparing for Use", section "Connecting External Devices"). Refer also to the documentation of the printer manufacturer on how to install the printer.

To install a local printer

1. If you use a USB device for driver installation, install the USB device on the instrument and connect it to the instrument before starting the installation.
2. If you use a LAN connection for driver installation, the corresponding network drives must be mounted before starting the installation.
3. Connect the printer via the USB connector on the front panel to the R&S ESL. The first page of the **Found New Hardware Wizard** dialog box is displayed.



4. Select the **Install the software automatically** option. The installation process runs automatically and a dialog box is displayed after the installation is completed. Proceed with step 15.

If the driver software cannot be found, an error message is displayed.

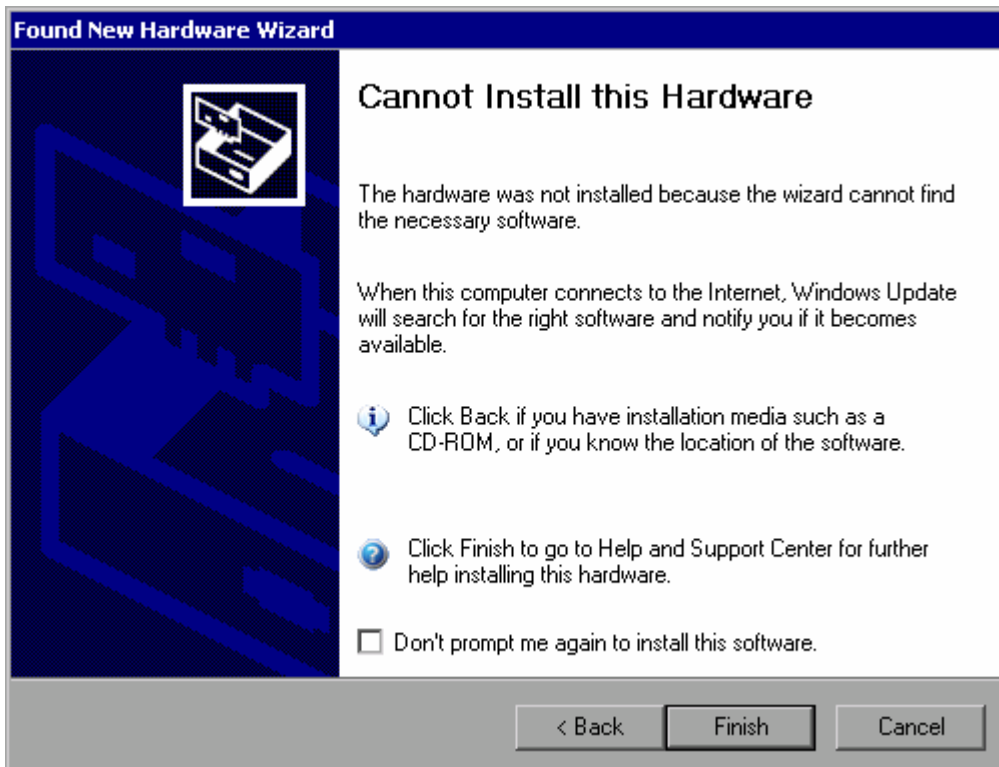

5. Deactivate the **Don't prompt me again to install this software** option.

6. Click **Finish**.
The first page of the wizard is displayed again.
7. Select the **Install from a list or specific location** option.
8. Click **Next**.
The second page of the wizard is displayed.

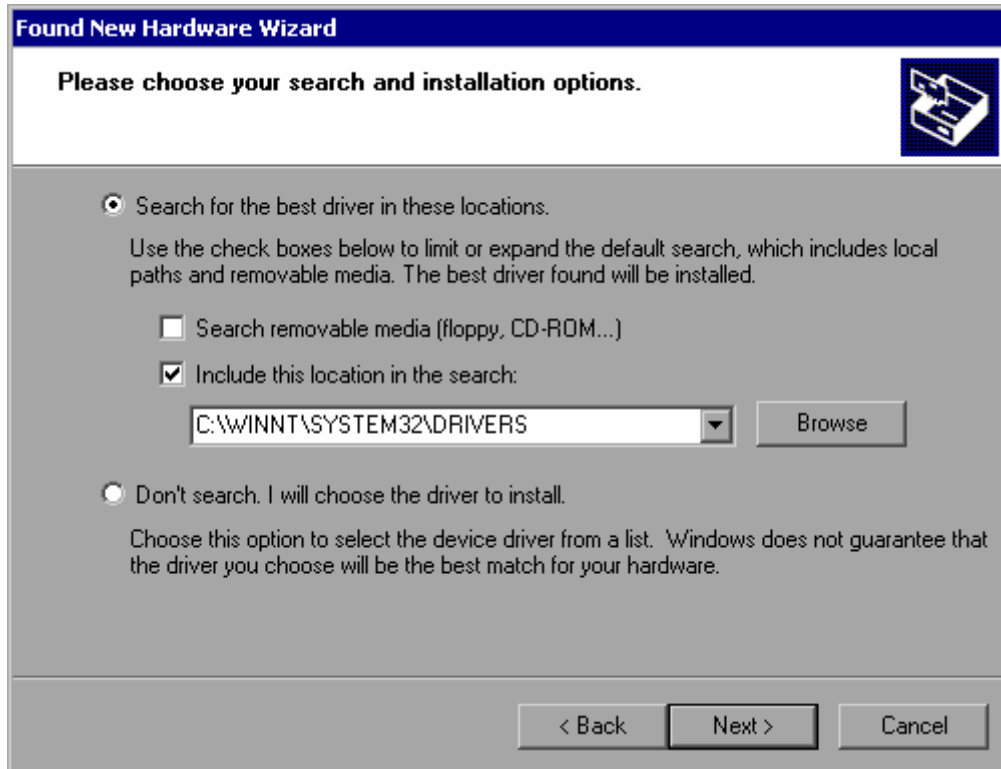

9. Insert the CD into the CD-ROM drive.
10. Activate the **Include this location in the search** option.
11. Click the **Browse** button.
The dialog box to browse for a folder is displayed.
12. On the CD-ROM drive, select the folder containing the printer drivers.
13. Click **OK**. This button is only active, if the selected folder contains drivers.
The second page of the wizard is displayed again.
14. Click **Next**.
The selected folder is searched for the printer driver and the printer driver files are copied to C:. After the installation is finished, a dialog box is displayed.



15. Click **Finish** to complete the installation.

Appendix B: LAN Interface

In this appendix, additional information on the LAN interface is given. How to connect the instrument to the network and configure the network protocols is described in chapter 2 "Preparing for Use", section "Configuring the LAN Interface".

Note: *In some of the following step-by-step instructions, user names and passwords must be entered. This requires a mouse and an external keyboard (see chapter 2, section "Connecting External Devices"). Therefore the operation is described via mouse and keyboard.*

Configuring the Network

After network support has been installed, data can be exchanged between the instrument and other computers, and network printers can be used.

Network operation is only possible if you are authorized to access network resources. Typical resources are file directories of other computers or even central printers. Authorization is assigned by the network or server administrator.

The operation on the network requires the following administration and actions:

- To change the computer name
- To change the domain or workgroup
- To operate the instrument without a network
- To create users
- To change the user password
- To log on to the network
- To deactivate the automatic login mechanism
- To reactivate the automatic login mechanism
- To map network drives
- To disconnect network drives
- To install a network printer
- To share directories (only with Microsoft networks)

NOTICE **Risk of network errors!**

Before connecting the instrument to the network or configuring the network, consult your network administrator, particularly in the case of large LAN installations. Errors may affect the entire network.

Never connect your analyzer to a network unprotected against virus infection because this may cause damage to the instrument software.

To integrate the instrument into your network, you can change the following system properties: computer name, domain, workgroup.

To change the computer name

1. Press the **Network Address** softkey.
The submenu is displayed.
2. Press the **Computer Name** softkey and enter the computer name.
3. If you have entered an invalid name, in the status line, the message "out of range" is displayed. The edit dialog box keeps open, and you can start afresh.
If the settings are correct, the configuration is saved, and you are prompted to restart the instrument.
4. Confirm the displayed message (**Yes** button) to restart the instrument.

To change the domain or workgroup

Note: Before you change other settings than described here, contact your network administrator.

1. In the **Start** menu, select **Settings, Control Panel** and then select **System**.
The **System Properties** dialog is displayed.
2. Select the **Computer Name** tab.

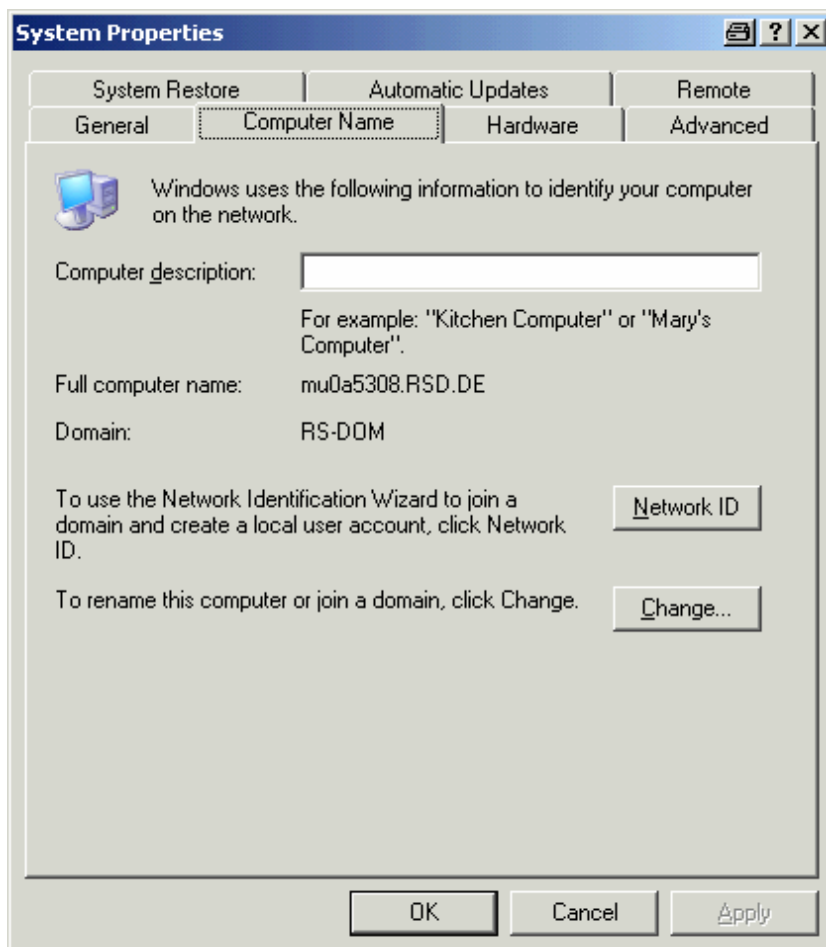

3. Click the **Change** button.
The dialog box for changing the computer name, domain and workgroup is displayed.

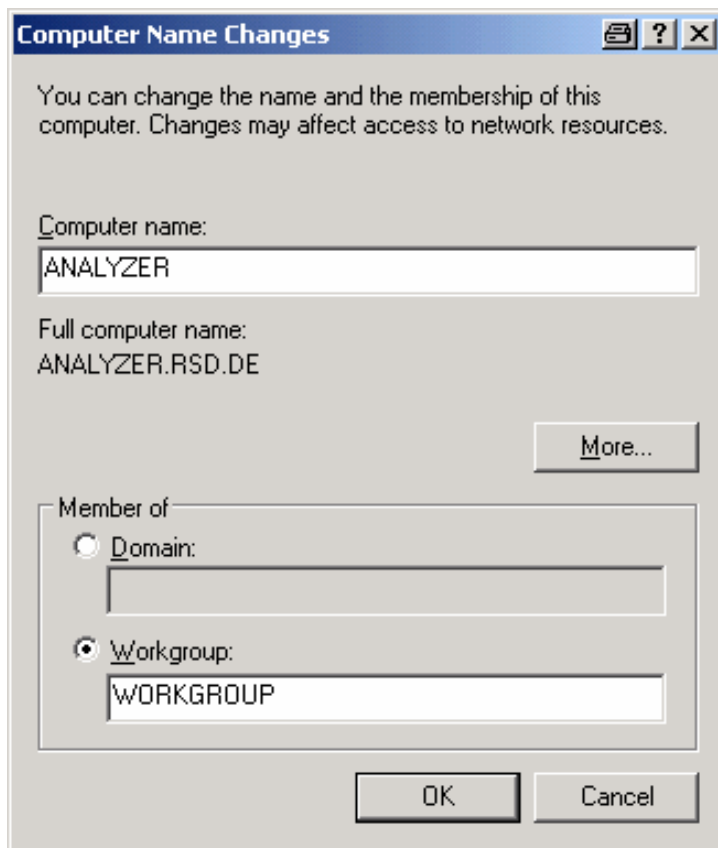

4. Enter a **Domain** or **Workgroup**.
5. Confirm the changes with **OK**.
6. If you are now prompted to restart the instrument, click **Yes**.
Windows will restart the system.

To operate the instrument without a network

If you want to operate the instrument either temporarily or permanently without a network connection, no special measures are necessary in contrast to Windows NT. Windows XP automatically detects the interruption of the network connection and does not set up the connection when the instrument is switched on.

If you are not prompted to enter the user name and password, proceed as described in the section "To reactivate the automatic login mechanism".

To create users

After the software for the network has been installed, the instrument will issue an error message the next time it is switched on, because there is no user named "instrument" (= user ID for Windows XP automatic login) in the network. Thus, a matching user must be created in Windows XP and in the network, the password must be adapted to the network password, and the automatic login mechanism must then be deactivated.

The network administrator is responsible for creating new users in the network. A new user can be created on the instrument by using the User Account wizard:

1. In the **Start** menu, select **Settings, Control Panel** and then select **User Accounts**.
The wizard for managing the user starts with the **Pick a task** dialog box.

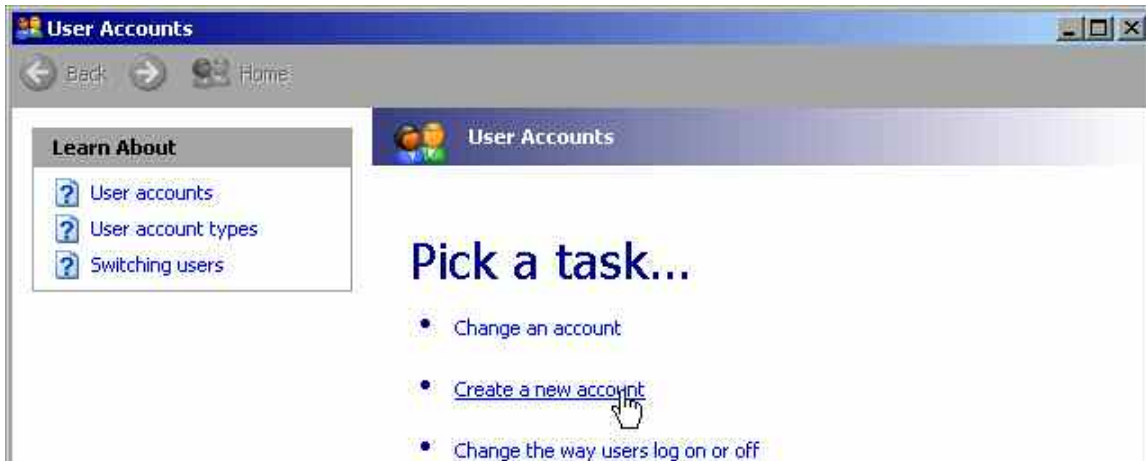

2. Click **Create a new account**.

The dialog box for entering a new computer name is displayed.



3. Enter the name of the new user in the text field and click **Next**.
The **Pick an account type** dialog box for defining the user's rights is displayed.



4. Select **Computer administrator**.
5. Click the **Create Account** button.
The new user has now been created.

Note: Proper firmware function requires administrator rights.

To change the user password

After the new user has been created on the instrument, the password must be adapted to the network password. This is also done by using the User Account wizard.

1. In the **Start** menu, select **Settings, Control Panel** and then select **User Accounts**. The wizard for managing the user starts with the **Pick a task** dialog box.

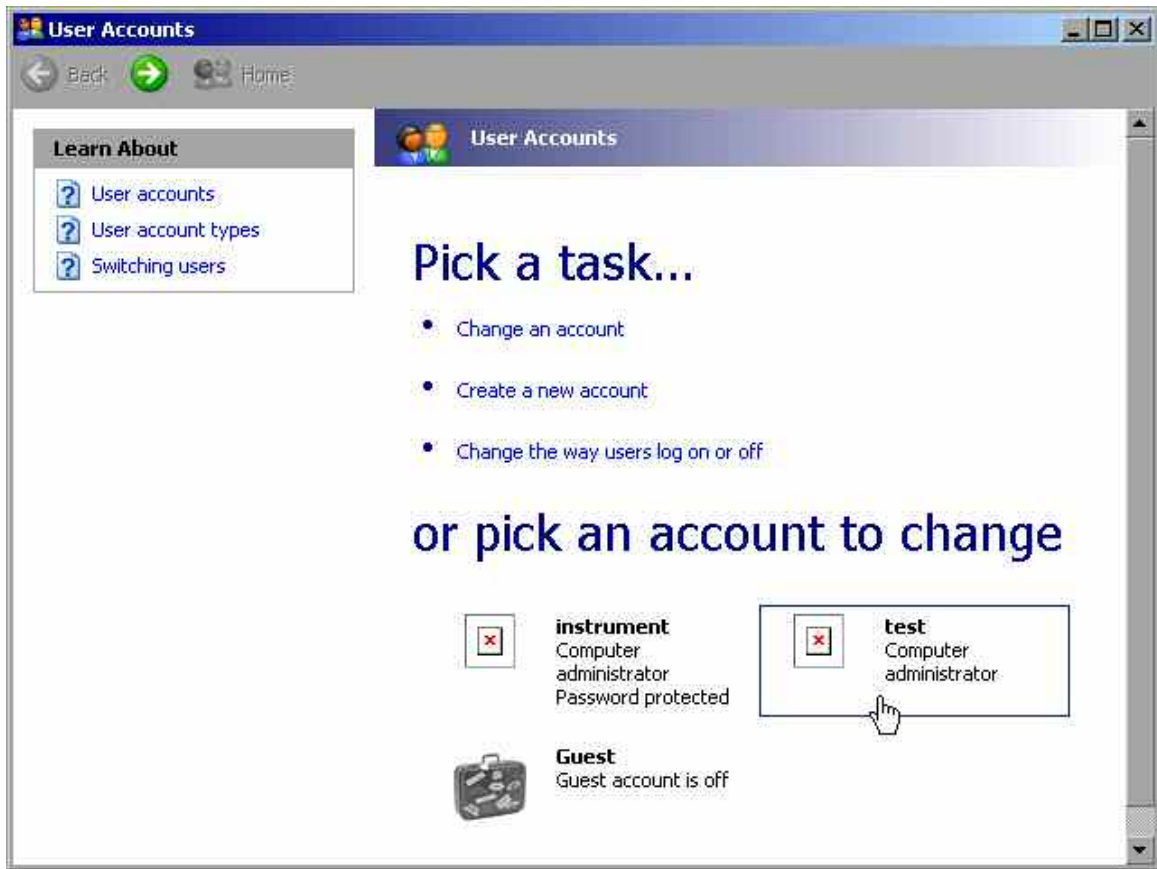

2. Click the desired user account (in the example: user **Test**). The dialog box for selecting the desired action is displayed.



3. Click **Create a password**. The dialog box for entering a new password is displayed.



4. Enter the new password in the upper text line and repeat it in the following line.
5. Click the **Create Password** button (at the end of the page).
The new password is now active.

To log on to the network

At the same time you log on to the operating system, you are automatically logged on to the network. As a prerequisite, the user name and the password must be identical under Windows XP and on the network.

To deactivate the automatic login mechanism

When shipped, the instrument is already configured to automatically log on under Windows XP. To deactivate the automatic login mechanism, perform the following steps:

1. In the **Start** menu, select **Run**.
The **Run** dialog box is displayed.
2. Enter the command `C:\R_S\INSTR\USER\NO_AUTOLOGIN.REG`.
3. Press the **ENTER** key to confirm.
The automatic login mechanism will be deactivated. The next time you switch on the instrument, you will be prompted to enter your user name and password before the firmware is started.

To reactivate the automatic login mechanism

1. In the **Start** menu, select **Run**.
The **Run** dialog box is displayed.
2. Enter the command `C:\R_S\INSTR\USER\AUTOLOGIN.REG`.
3. Press the **ENTER** key to confirm.

The automatic login mechanism will be reactivated. It will be applied the next time the instrument is switched on.

To map network drives

1. Press the **FILE** key.
2. Press the **File Manager** softkey.
3. Press the **More** softkey.
4. Press the **Network Drive** softkey.
The **Map Network Drive** dialog box is displayed.

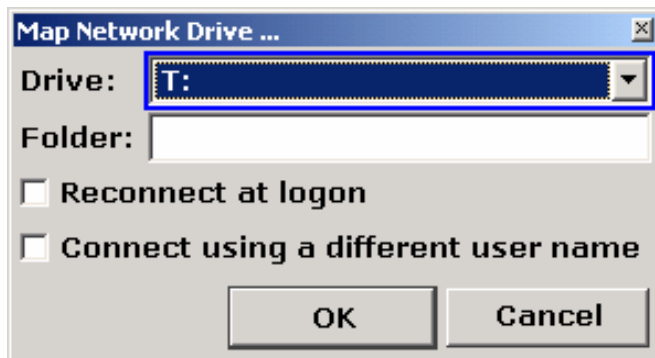

5. Press the **Map Network Drive** softkey to set the focus on the **Drive** list.
6. Press **ENTER** to open the network drive list and select the drive you want to map using the arrow keys.
7. If you want the connection to be set up automatically each time the instrument is started, in the **Map Network Drive** dialog box, activate the **Reconnect at logon** option.
8. If you want to connect using a different user name, activate the **Connect using a different user name** option.
The **Map Network Drive** dialog box is extended by the **User name** and **Password** fields.

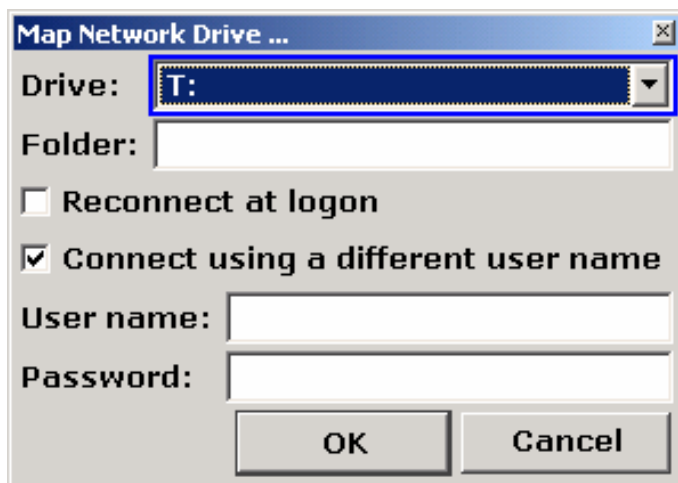

9. Enter your user name and password.
10. Confirm with **OK**.
The drive is displayed in the Explorer.

Note: Only networks are connected that you authorized to access.

To disconnect network drives

1. Press the **FILE** key.
2. Press the **File Manager** softkey.
3. Press the **More** softkey.
4. Press the **Network Drive** softkey.
5. Press the **Disconnect Network Drive** softkey.
The **Disconnect Network Drive** dialog box is displayed.
6. In the **Drive** list, select the drive you want to disconnect.
7. Confirm with **OK**.

To install a network printer

After installation the instrument must be configured for printout with this printer. How to select and configure printers is described in chapter 2, section "R&S ESL Setup".

1. Press the **Print** key on the front panel.
The menu will be displayed.
2. Press the **Install Printer** softkey to open the **Printers and Faxes** dialog box.

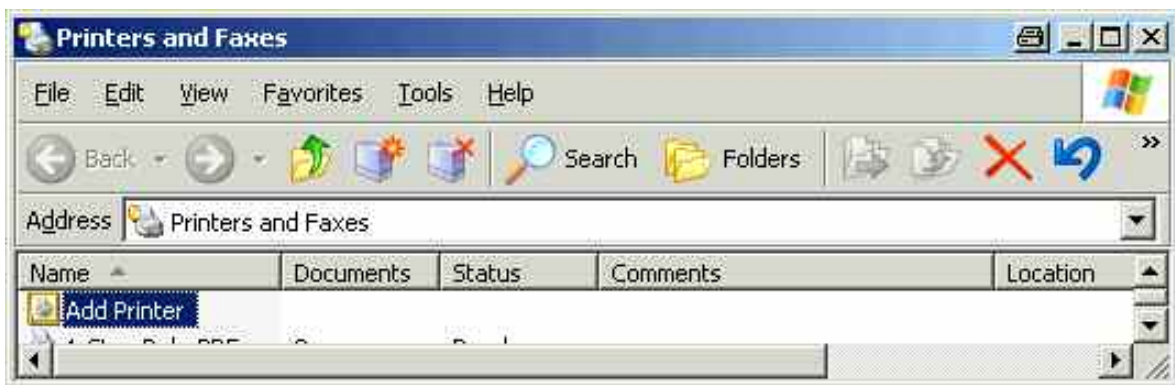

3. Mark the focused **Add Printer** list item by pressing the **RIGHTARROW** key and confirm by pressing the **ENTER** key.
The printer wizard with its first pane is displayed.



4. Press the rotary knob or **ENTER** key to continue. The Local or Network Printer pane is displayed.

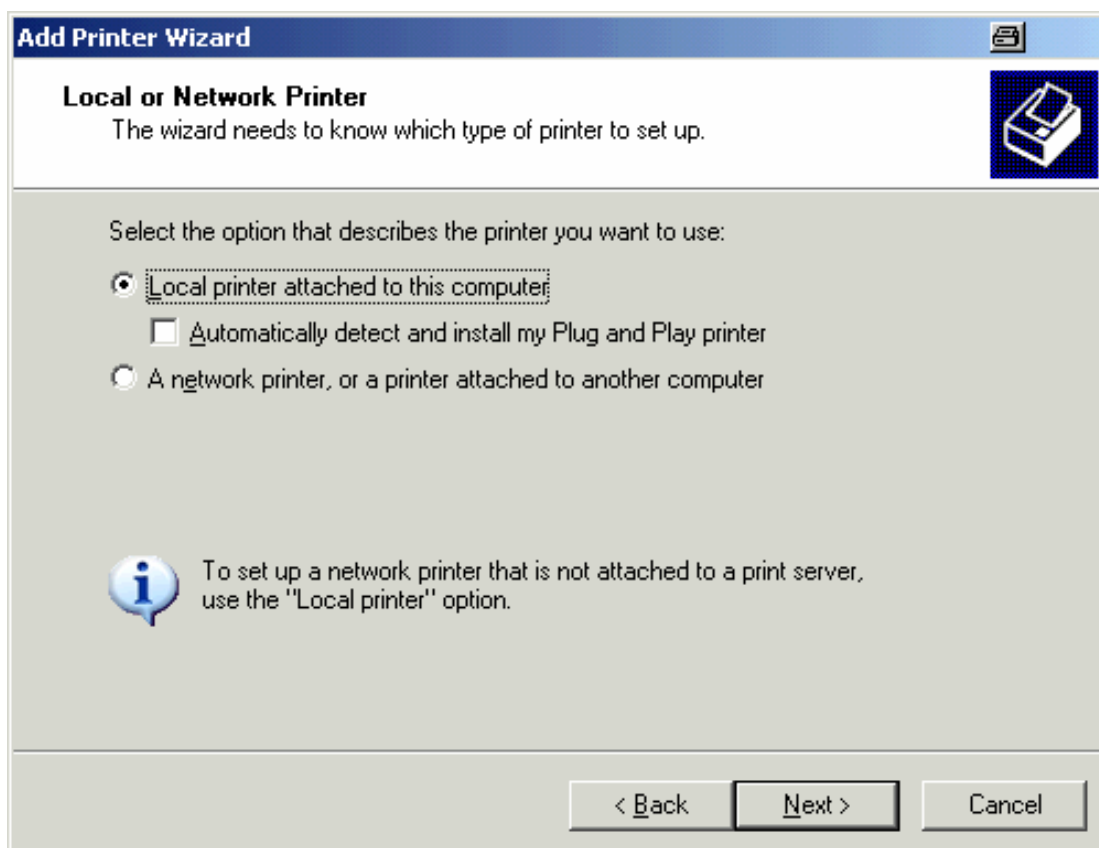

5. Press the **DNARROW** key to activate the **A network printer, or a printer attached to another computer** option.

6. Confirm by pressing **ENTER** key.
The **Specify a Printer** pane is displayed.

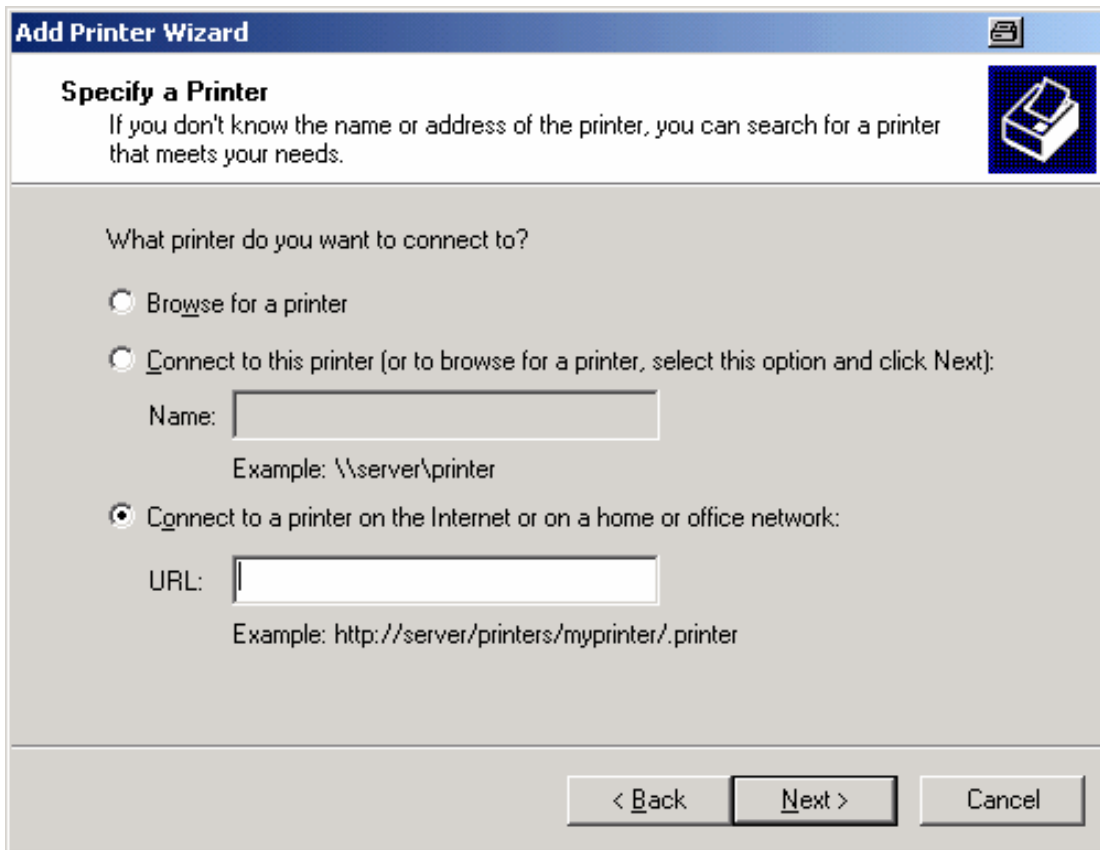

7. Confirm the activated **Browse for a printer** option by pressing the **ENTER** key.
8. Focus the **Next** button using the tab keys and confirm by pressing the **ENTER** key.
All available printers are displayed.

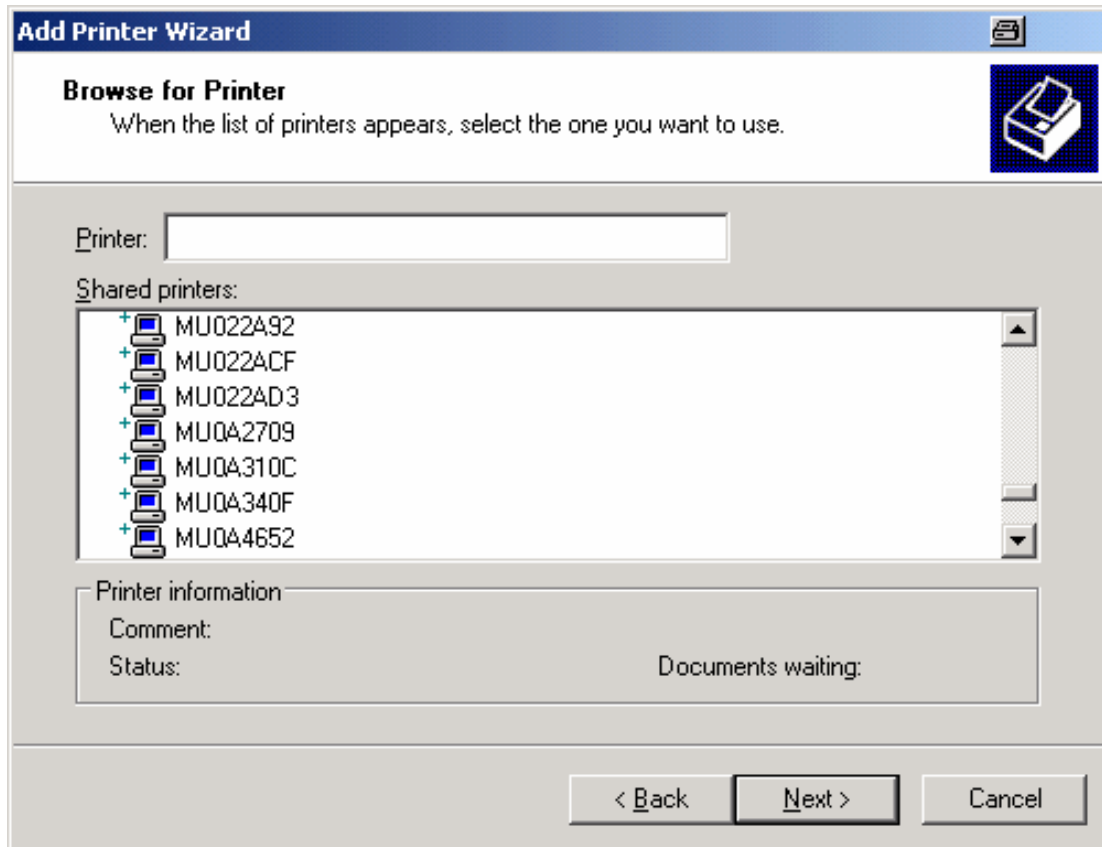

9. Mark a printer using the arrow keys and confirm by pressing the **ENTER** key.
10. When you are prompted to confirm the installation of a suitable printer driver, press the **ENTER** key.
The available printer drivers are displayed.

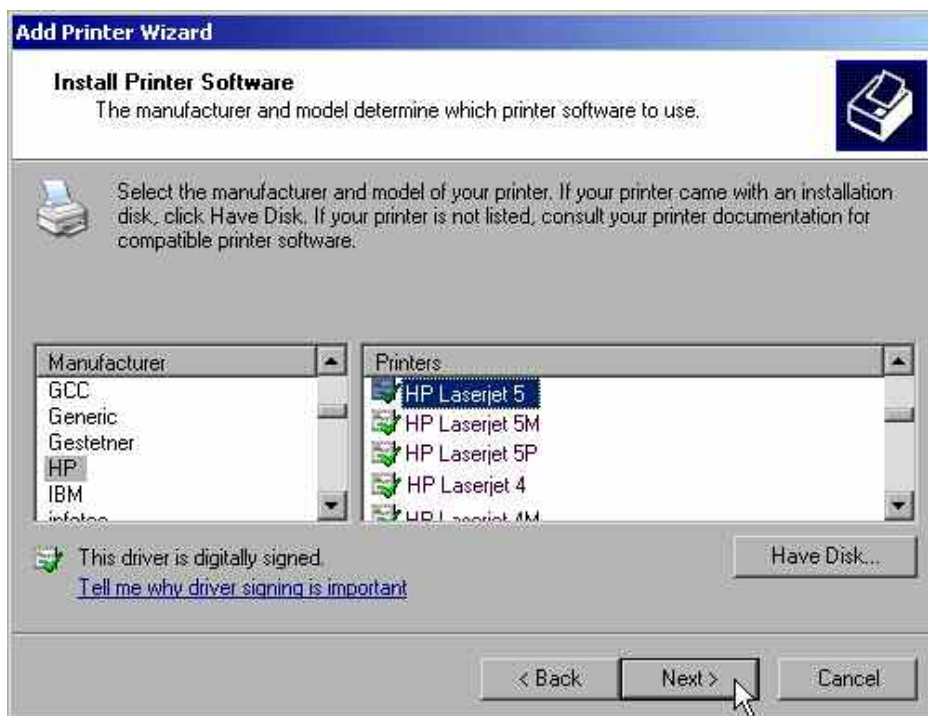

11. In the **Manufacturers** list, mark the appropriate manufacturer using the arrow keys and confirm by pressing the **ENTER** key.

In this example, an HP Laserjet 5 printer is installed as a network printer.

12. Press the **FIELD RIGHT** key to go to the **Printers** list.
13. In the **Printers** list, mark the appropriate printer driver using the arrow keys and confirm by pressing the **ENTER** key.
14. If the desired printer type is not in the list, its driver has not yet been installed. In this case, focus the **Have Disk** button and confirm by pressing the rotary knob or the **ENTER** key. Insert the disk with the corresponding printer driver. Close the **Install From Disk** dialog box (**OK** button) and select the desired printer driver.
15. Focus the **Next** button using the tab keys and confirm by pressing the **ENTER** key. The **Standard Printer** pane is displayed.

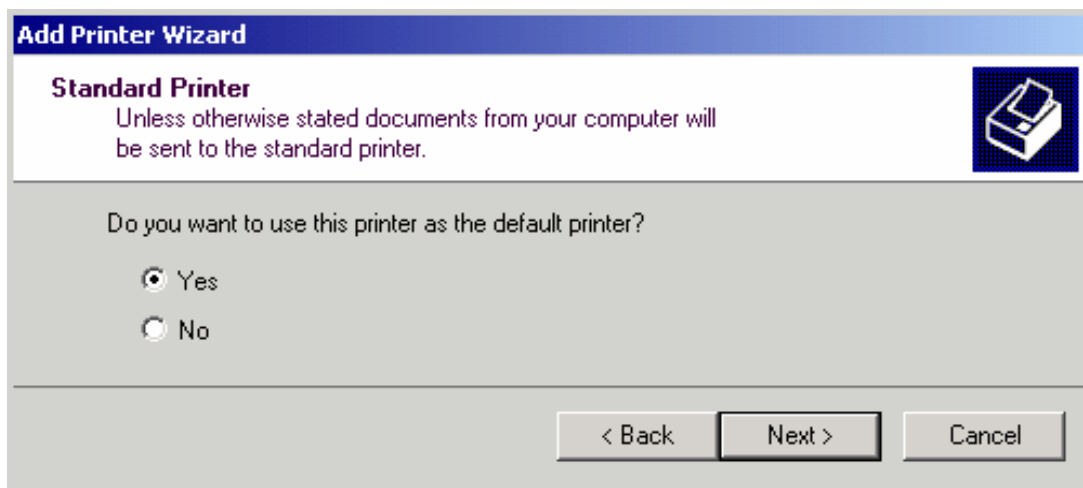

16. If you want to set the printer as default printer, press the **FIELD RIGHT** key and select **Yes** using the **UPARROW** key.
17. Focus the **Next** button using the tab keys and confirm by pressing the **ENTER** key. The final pane of the installation wizard is displayed.

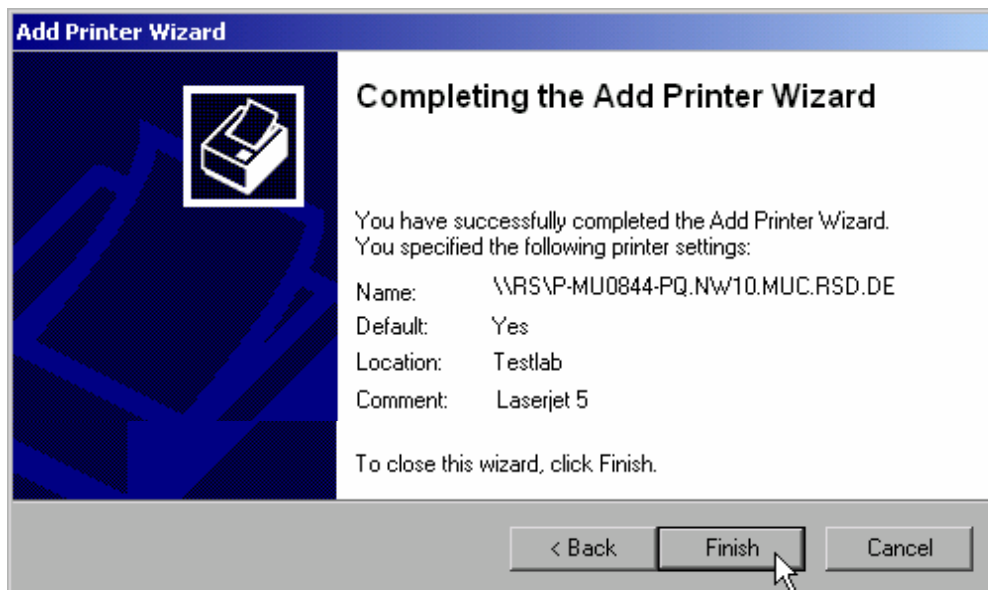

18. Focus the **Finish** button using the tab keys and confirm by pressing the **ENTER** key.

To share directories (only with Microsoft networks)

Sharing directories makes data available for other users. This is possible only in Microsoft networks. Sharing is a property of a file or directory.

1. In the **Start** menu, select **Programs, Accessories** and then select **Windows Explorer**.
2. Click the desired folder with the right mouse button.
3. In the context menu, select **Sharing and Security**.
The dialog for sharing a directory is displayed.

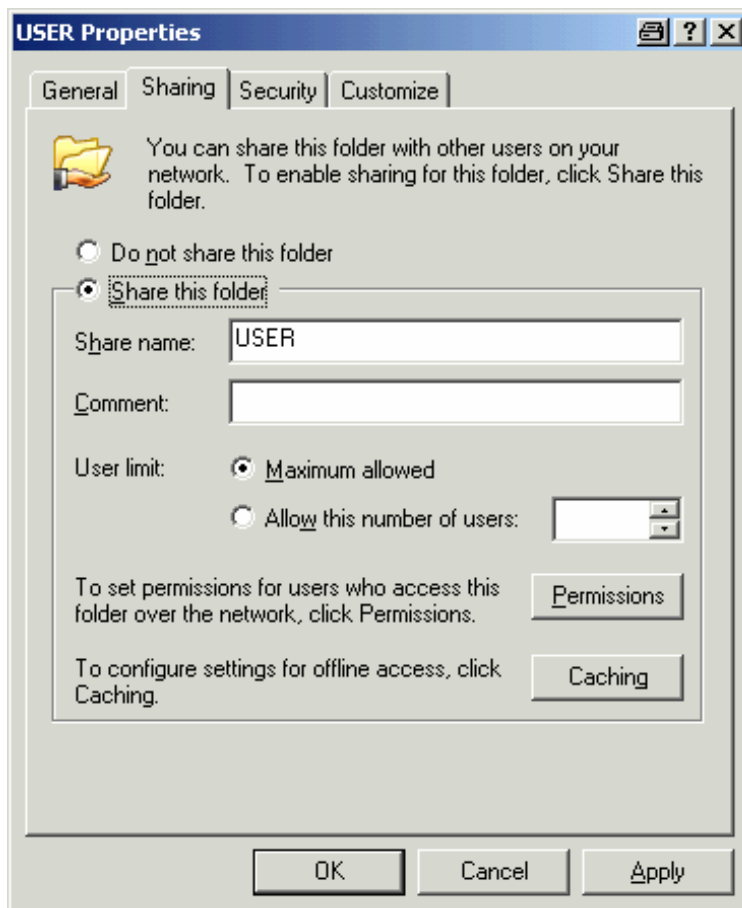

4. Open the **Sharing** tab.
5. Select the **Share this folder** option.
6. You can change the following settings as necessary:

Share name	Name under which the directory is displayed in the Explorer
Comment	Comments regarding the shared directory
User limit	Maximum number of users who can access the directory simultaneously
Permissions	User access rights (read only, read and write, all)
Caching	Local buffering of the directory contents for quicker access

7. Click **OK** to confirm the settings.
The drive will be shared and, in the Explorer, marked with a hand under the directory symbol:



Remote Operation with XP Remote Desktop

In production test and measurement, a common requirement is central monitoring of the T&M instruments for remote maintenance and remote diagnostics. Equipped with the Remote Desktop software of Windows XP, the R&S ESL ideally meets requirements for use in production. The computer that is used for remote operation is here called "controller":

- Access to the control functions via a virtual front panel (*soft front panel*)
- Printout of measurement results directly from the controller
- Storage of measured data on the controller's hard disk

The analyzer is connected via a LAN, in which case Windows XP also supports a connection via a modem. This section describes the configuration of the R&S ESL and the Remote Desktop Client of the controller. Details on how to set up a modem connection are described in the Window XP documentation.

To configure the R&S ESL for remote operation

1. In the **Start** menu, select **Settings** and then select **Network Connections**.
2. In the **Network Connections** dialog box, select **Local Area Connection**. The **Local Area Connection Status** dialog box is displayed.

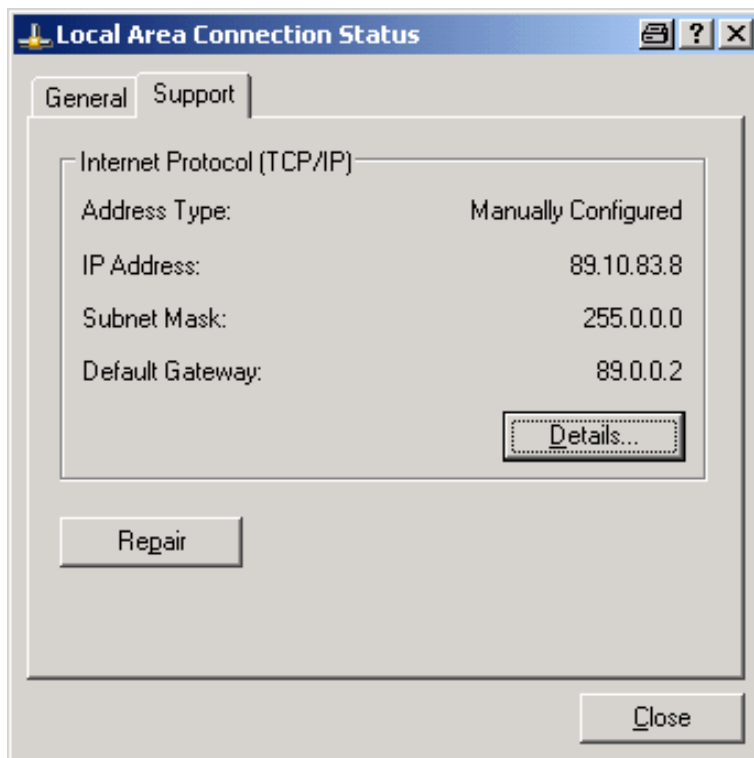

3. Open the **Support** tab. The current TCP/IP configuration is displayed.
4. If, in the **Address Type** field, **Assigned by DHCP** is displayed, proceed with the next step. Otherwise, simply note the IP address and proceed with step 6.
5. Create a fixed IP address for the TCP/IP protocol as described in chapter 2 "Preparing for Use", section "Configuring the Network Card".

Note: To avoid problems, use a fixed IP address. When a DHCP server is used, a new IP address is assigned each time the instrument is restarted. This address must first be determined on the instrument itself. Thus, using a DHCP server is not suitable for remote operation of the R&S ESL.

6. In the **Start** menu, select **Settings, Control Panel** and then select **System**.

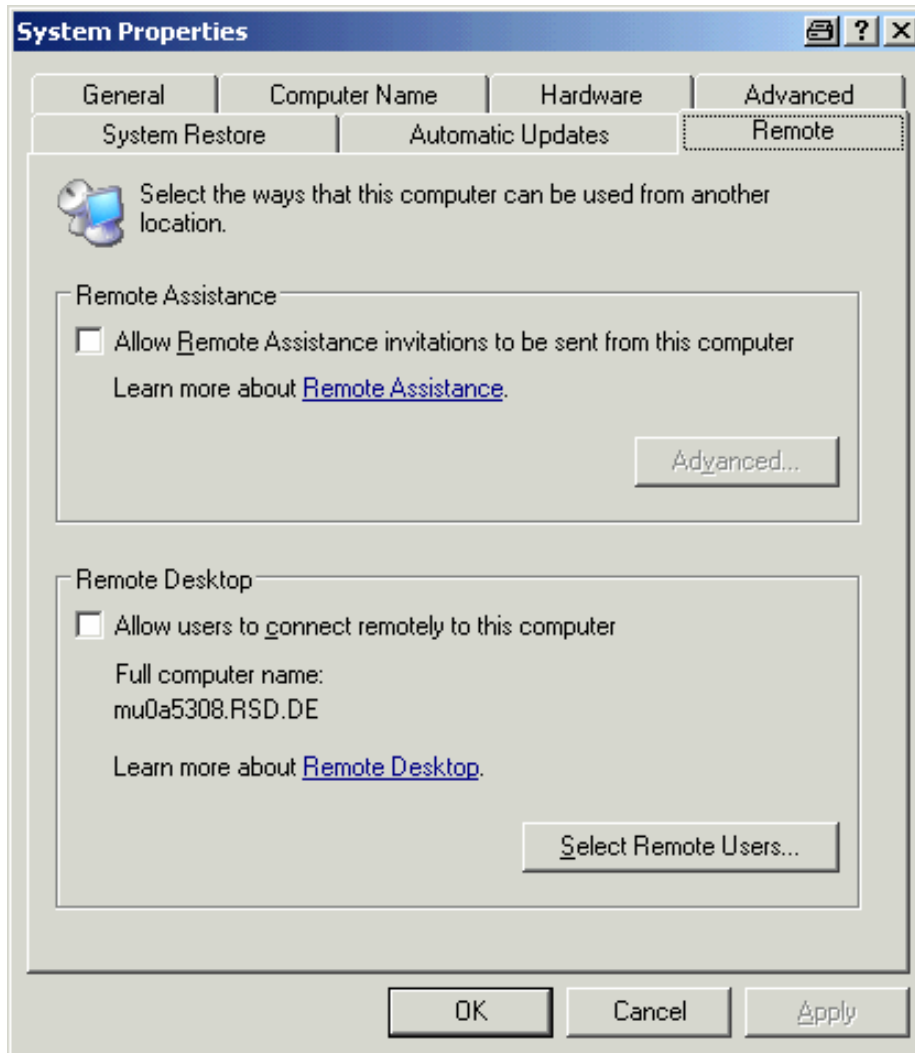

7. Open the **Remote** tab.
8. Under **Remote Desktop**, activate the **Allow users to connect remotely to this computer** option.
9. If necessary, click **Select Remote Users** and select users created on the R&S ESL who are to be given access to the R&S ESL also via Remote Desktop.

Note: The user account under which configuration is carried out is automatically enabled for Remote Desktop.

10. Click **OK** to confirm the settings.

The R&S ESL is now ready for connection setup with the Remote Desktop program of the controller.

To configure the controller

Note: With Windows XP, Remote Desktop Client is part of the operating system and can be accessed via **Start – Programs – Accessories – Communications – Remote Desktop Connection**.

For other versions of Windows, Microsoft offers the Remote Desktop Client as an add-on.

1. In the **Start** menu, select **Programs, Accessories, Communications** and then select **Remote Desktop Connection**.
The **Remote Desktop Connection** dialog box is displayed.
2. Click the **Options >>** button.
The dialog box is expanded to display the configuration data.

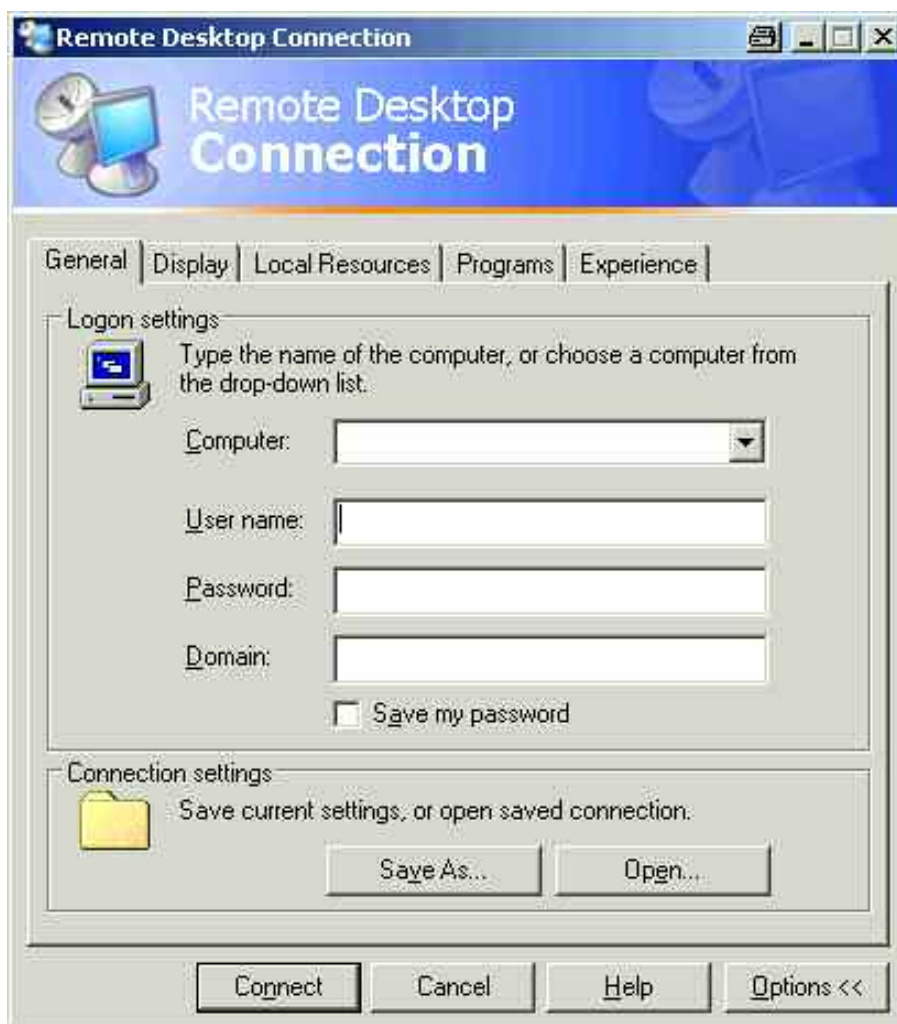

3. Open the **Experience** tab.
The settings on this tab are used to select and optimize the connection speed.



4. In the list, select the appropriate connection (for example: LAN (10 Mbps or higher)). Depending on your selection (and how powerful the connection is), the options are activated or deactivated.
5. If you want to improve the performance, you can deactivate the **Desktop background**, **Show contents of window while dragging** and **Menu and window animation** options.
6. Open the **Local Resources** tab for enabling printers, local drives and serial interfaces.



7. If you will need to access drives of the controller from the R&S ESL (e.g. in order to store settings or to copy files from the controller to the R&S ESL), activate the **Disk drives** option.
Windows XP will then map drives of the controller to the like network drives.
8. If you want to use printers connected to the controller by accessing them from the R&S ESL, activate the **Printers** options. Do not change the remaining settings.
9. Open the **Display** tab.
The options for configuring the R&S ESL screen display are displayed.

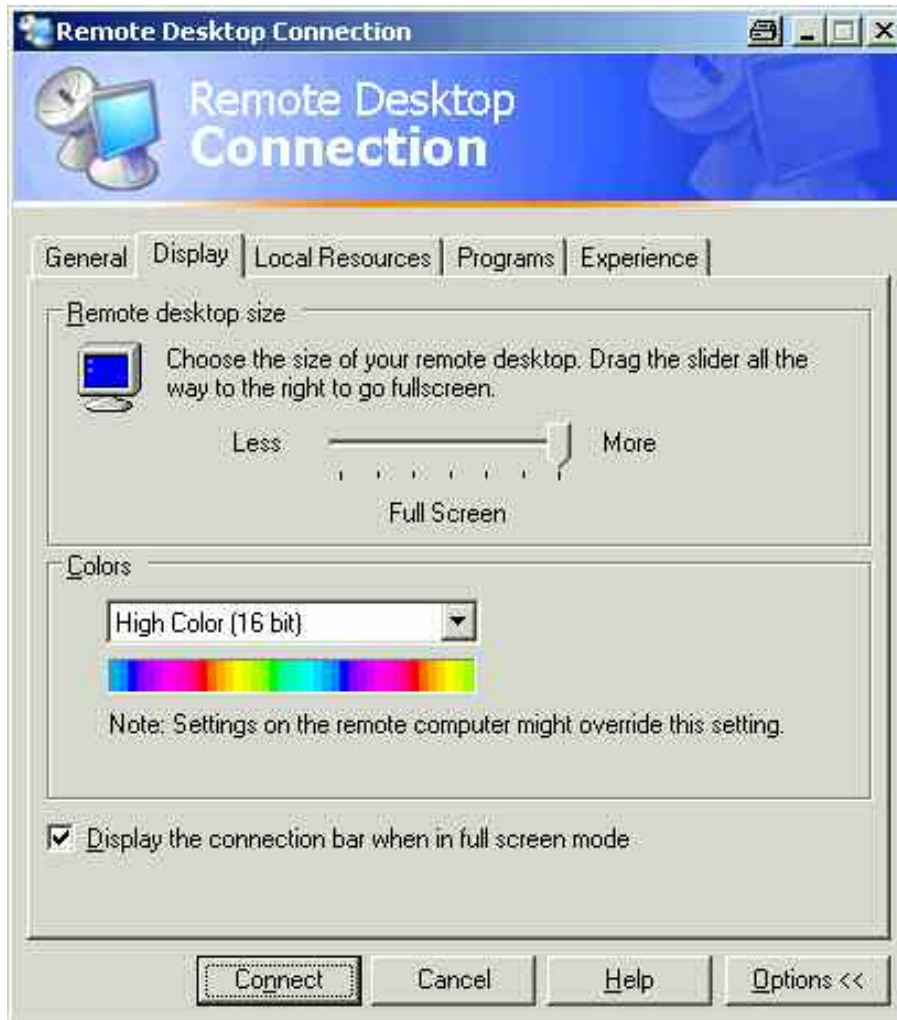

10. Under **Remote desktop size**, you can set the size of the R&S ESL window on the desktop of the controller.
11. Under **Colors**, do not change the settings.
12. Set the **Display the connection bar when in full screen mode** option:
 - If activated, a bar showing the network address of the R&S ESL will appear at the top edge of the screen. You can use this bar to reduce, minimize or close the window.
 - If deactivated, the only way you can return to the controller desktop from the R&S ESL screen in full screen mode is to select **Disconnect** from the **Start** menu.

To set up a connection to the R&S ESL

1. In the **Remote Desktop Connection** dialog box (see "To configure the controller"), open the **General** tab.



2. In the **Computer** field, enter the IP address of the R&S ESL.
3. In the **User name** field, enter "instrument".
4. In the **Password** field, enter "instrument".
5. If you want to save the connection configuration for later use:
 - Click the **Save As** button.
The **Save As** dialog box is displayed.
 - Enter the name for the connection information (*.RDP).
6. If you want to load an existing connection configuration:
 - Click the **Open** button.
The **Open** dialog box is displayed.
 - Select the *.RDP file.

7. Click the **Connect** button.
The connection will be set up.
8. If, on the **Local Resources** tab, the **Disk drives** option is activated, a warning is displayed indicating that the drives are enabled for access from the R&S ESL.



9. Click **OK** to confirm the warning.
After a few moments, the R&S ESL screen is displayed. If the R&S ESL application is displayed on screen immediately after connection setup, shutdown and restart are not necessary.
10. If a dark screen appears or a dark square appears in the upper left-hand corner of the screen, you must restart the R&S ESL in order to see the modified screen resolution:
 - Press the key combination **ALT+F4**.
The R&S ESL firmware will be shut down, which may take a few seconds.
 - On the desktop, double-click the R&S ESL Analyzer Interface icon.



The firmware will restart and then automatically open the **Soft Front Panel**, i.e. the user interface on which all front panel controls and the rotary knob are mapped to buttons. To deactivate or activate the **Soft Front Panel**, press the F6 key.

After the connection is established, the R&S ESL screen is displayed in the **Remote Desktop** application window.

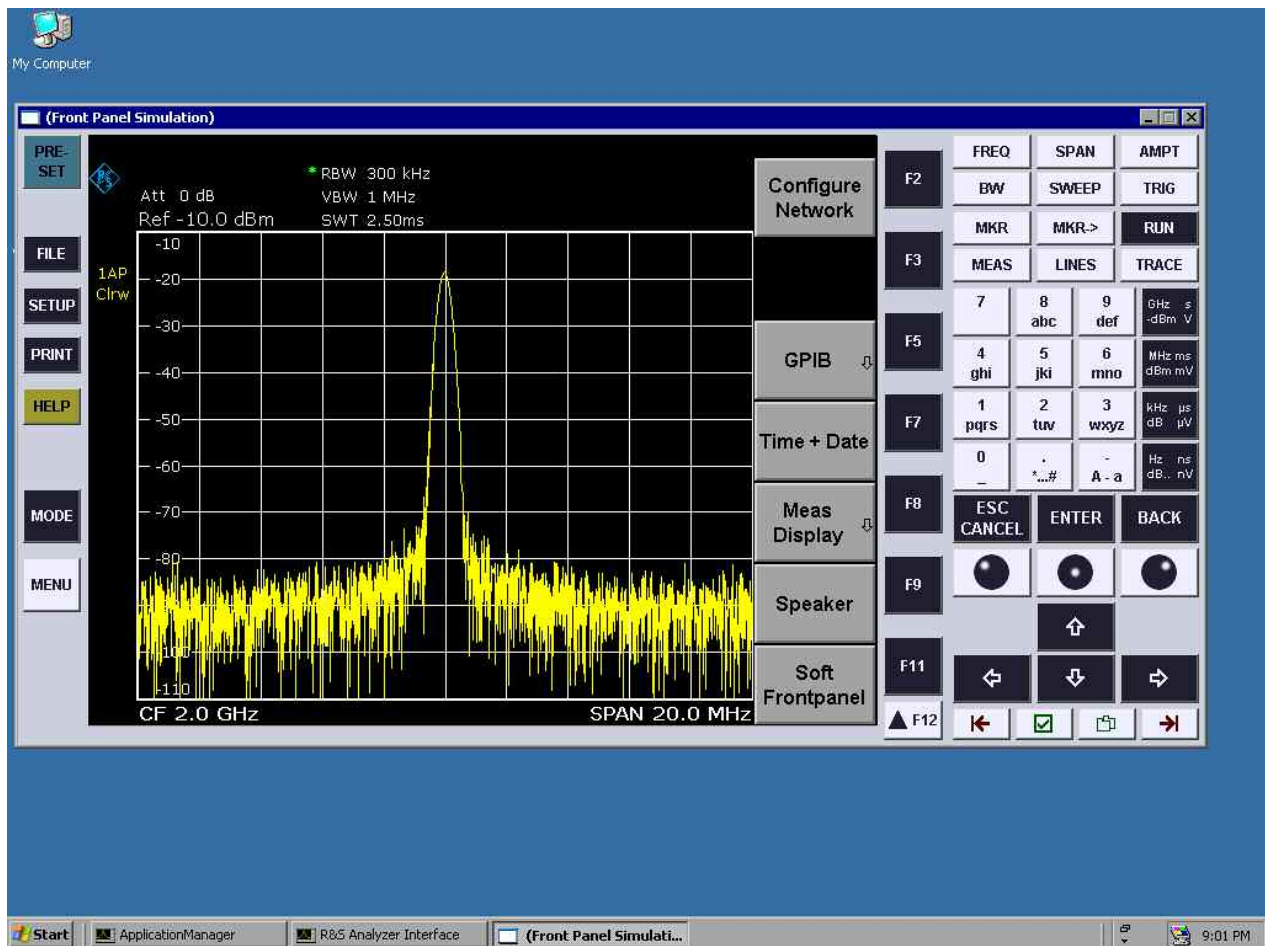

You can operate all keys and softkeys by using the mouse. The rotary knob is simulated by means of the knob buttons.

The Windows XP **Start** menu can be made available by expanding the **Remote Desktop** window to full size.

During the connection with the controller, the login entry is displayed on the R&S ESL screen.

To end Remote Desktop control

The connection can be terminated by the controller or by a user at the R&S ESL:

- On the controller, close the **Remote Desktop** window.
 - The connection to the R&S ESL is terminated (any time is possible).
- On the R&S ESL, a user logs on.
 - The connection to the controller is terminated as a result. A message is displayed on the controller display indicating that another user has assumed control of the instrument.

To restore the connection to the R&S ESL

- Follow the instructions provided in the section "To set up a connection to the R&S ESL". If the connection is terminated and then restored, the R&S ESL remains in the same state.

To deactivate the R&S ESL via remote operation

1. Click the R&S ESL soft front panel and close the application with the key combination **ALT+F4**.
2. Click the desktop and press the key combination **ALT+F4**.
A safety query is displayed to warn you that the instrument cannot be reactivated via remote operation and asks you whether you want to continue the shutdown process.
3. Respond to the safety query with **Yes**.
The connection with the controller is terminated and the R&S ESL is deactivated.

RSIB Protocol

When shipped, the instrument is equipped with the RSIB protocol, which allows you to control the instrument not only via Visual C++ and Visual Basic programs but also via the two Windows applications WinWord and Excel as well as via National Instruments LabView, LabWindows/CVI and Agilent VEE.

For more information about the RSIB protocol, refer to the Operating Manual on CD.

Index

7

75 Ω (enhancement label) 4.8

A

AC power supply
 connecting to 2.7
 connector 1.10
 AC power switch 1.10
 AF output connector 1.6
 aligning 2.8
 alphanumeric parameters 4.13
 AP (trace information) 4.7
 arrow keys 4.11
 Att (hardware setting) 4.5
 automatic loading
 settings 5.35
 auxillary port connector 1.12
 AV (trace information) 4.7

B

battery pack
 charging 2.11

C

recommended calibration interval 2.4
 canceling entry 4.9
 charging battery pack 2.11
 checking the accessories 2.4
 cleaning the outside 2.12
 CLRWR (trace information) 4.7
 CNT (marker functions) 4.4, 4.5
 color
 defining own set 2.18, 2.19
 printout 2.22
 screen 2.17
 screen objects 2.18, 2.19
 concluding entry 4.9
 connector
 AC power supply 1.10
 AF output 1.6
 auxillary port 1.12
 DC power supply 1.13, 1.14
 external reference 1.11
 external trigger/gate input 1.10
 front panel (optional) 1.7
 front panel (standard) 1.6
 GPIB 1.13
 IF/video output 1.12
 LAN 1.10
 monitor 1.11
 noise source control 1.11
 power sensor 1.11
 probe power 1.6
 rear panel (optional) 1.11
 rear panel (standard) 1.10
 RF input 1.6
 tracking generator 1.7

USB 1.7

D

date
 setting 2.15
 DC power supply connector 1.13, 1.14
 default colors 2.17
 Demod (hardware setting) 4.4
 demodulation
 AM 4.4
 FM 4.4
 diagram area
 enhancement labels 4.8
 hardware setting 4.4
 hardware settings 4.5
 status display 4.6
 trace information 4.7
 dialog boxes
 description 4.15
 working with 4.13, 4.15
 display power save 2.20

E

edit dialog box 4.13
 enhancement labels 4.8
 entry
 canceling 4.9
 concluding 4.9
 Ext (enhancement label) 4.8
 external devices 2.13
 connecting 2.13
 connecting (example memory stick) 2.13
 external monitor 2.14
 connecting 2.14
 external reference connector 1.11
 external trigger/gate input connector 1.10
 ExtRef (status display) 4.6

F

firmware
 options 3.3
 update 3.2
 firmware options 2.9
 frequency reference 2.15
 front panel view 1.2
 Frq (enhancement label) 4.8
 functional test 2.8
 fuses
 replacing 2.11
 FXD (marker functions) 4.4, 4.5

G

GAT (enhancement label) 4.8
 GPIB
 address 2.17
 ID response string 2.17
 GPIB connector 1.13

- H**
- hardware options 2.9
 - hardware settings
 - display 4.5
- I**
- IF/video output connector 1.12
 - I FOVL (status display) 4.6
 - installing
 - local printer A.1
 - network printer B.8
 - instrument modes 2.6
 - interface
 - LAN B.1
- K**
- key
- alphanumeric 4.9
 - BACK 4.10
 - CHECKMARK 4.12
 - decimal point 4.9
 - DNARROW 4.11
 - ENTER 4.10
 - ESC/CANCEL 4.9
 - FIELD LEFT 4.11
 - FIELD RIGHT 4.11
 - function keys front panel 1.4
 - GHz/dBm 4.9
 - Hz/-dB 4.9
 - kHz/dB 4.9
 - LEFTARROW 4.11
 - MENU 4.12
 - NEXT TAB 4.11
 - RIGHTARROW 4.11
 - sign 4.9
 - unit 4.9
 - UPARROW 4.11
- L**
- LAN interface B.1
 - connector 1.10
 - LIMIT CHECK (hardware setting) 4.4, 4.5
 - loading
 - instrument configuration 5.34
 - measurement data 5.34
 - local printer A.1
 - LOUNL (status display) 4.6
- M**
- MAXH (trace information) 4.7
 - measurement data
 - loading 5.34
 - storing 5.34
 - measurement example
 - AF of AM-modulated signal 5.21
 - AF of FM-modulated signal 5.29
 - AM modulation 5.19
 - first and second harmonic 5.12
 - level and frequency 5.7
 - power of burst signals 5.23
 - separating signals 5.15
 - signal frequency using frequency counter 5.10
 - signal-to-noise ratio 5.26
 - memory stick
 - connecting 2.13
 - MI (trace information) 4.7
 - MINH (trace information) 4.7
 - MOD (marker functions) 4.4, 4.5
 - mode
 - off 2.6
 - on 2.6
 - standby 2.6
 - monitor
 - external 2.14
 - monitor connector 1.11
 - MT (hardware setting) 4.4
 - multiple signals measurement 5.15
- N**
- NCor (enhancement label) 4.8
 - network B.1
 - automatic logon B.6
 - changing configuration B.2
 - changing user passwords B.5
 - configuring card 2.23
 - connecting drives B.7
 - connecting to 2.23
 - creating users B.3
 - disconnecting drives B.8
 - printer B.8
 - sharing directories B.13
 - NOI (marker functions) 4.4, 4.5
 - noise source control connector 1.11
 - numeric parameters 4.13
- O**
- off mode 2.6
 - Offset (hardware setting) 4.5
 - on mode 2.6
 - Online Help
 - working with 4.19
 - operating system
 - Windows XP 2.24
 - options 3.3
 - activating 3.3
 - firmware 2.9
 - hardware 2.9
 - OVEN (status display) 4.6
 - OVL D (status display) 4.6
- P**
- PA (enhancement label) 4.8
 - parameters
 - entering 4.13
 - PHN (marker functions) 4.4, 4.5
 - PK (trace information) 4.7
 - plug&play printers A.1
 - power save
 - display 2.20
 - power sensor connector 1.11
 - power supply
 - connecting to 2.7
 - connector (AC) 1.10

- connector (DC) 1.13, 1.14
- PREAMP (hardware setting) 4.4
- preparing for operation 2.2, 2.5
- printer
 - alternative configuration 2.21
 - configuring 2.21
 - installing local printer A.1
 - installing network printer B.8
 - local A.1
 - plug&play A.1
- printout
 - colors 2.22
- probe power connector 1.6
- protocol
 - RSIB B.24
- Pwr Max (enhancement label) 4.8
- Q**
- QP (trace information) 4.7
- R**
- rackmounting 2.5
- RBW (hardware setting) 4.4, 4.5
- rear panel view 1.8
- Ref (hardware setting) 4.5
- reference
 - external 2.15
 - internal 2.15
- remote control
 - command synchronization 6.9
 - display power save 6.7
 - global variables 6.5
 - initialization 6.5
 - instrument settings 6.8
 - library 6.2
 - sending commands 6.7
 - switching screen display on and off 6.6
 - switching to manual operation 6.7
- remote control programming example
 - changing default settings 6.10
 - printout 6.21
 - reading out trace data 6.18
 - storing and loading settings 6.19
 - using markers and delta markers 6.13
- remote operation
 - configuring for B.14
 - deactivating the instrument B.24
 - ending session B.23
 - RSIB protocol B.24
 - setting up a connection B.21
- replacing fuses 2.11
- RF input connector 1.6
- RM (trace information) 4.7
- rotary knob 4.10
- S**
- SA (trace information) 4.7
- screen colors 2.17
- self test 2.8
- service pack 2.26
- setting
 - date 2.15
 - time 2.15
- settings
 - automatic loading 5.35
 - loading 5.34
 - storing 5.33
- Sgl (enhancement label) 4.8
- ship damage inspection 2.4
- sinusoidal signal measurements 5.7
 - harmonics 5.12
- softkey 4.12
 - Color On/Off 2.22
 - Colors 2.22
 - Default Colors 2.17
 - Device Setup 2.21
 - Firmware Update 3.2
 - GPIOB 2.16
 - ID String Factory 2.17
 - ID String User 2.17
 - More 4.12
 - Select Color Set 2.18, 2.19
 - Select Object 2.18, 2.19
 - Select Print Color Set 2.22
 - Time + Date 2.16
- software
 - approved for instrument 2.25
 - stand alone instrument B.3
 - standby mode 2.6
 - Start menu 2.26
 - status display 4.6
 - storing
 - instrument configuration 5.33
 - measurement data 5.34
 - switching off the instrument 2.10
 - switching on the instrument 2.8
 - SWT (hardware setting) 4.5
- T**
- Tdf (enhancement label) 4.8
- time
 - setting 2.15
- TOI (marker functions) 4.4, 4.5
- trace information 4.7
 - detector type 4.7
 - trace number 4.7
- traces
 - loading 5.34
 - storing 5.34
- tracking generator connector 1.7
- Trg (enhancement label) 4.8
- TRK (marker functions) 4.4, 4.5
- U**
- UNCAL (status display) 4.6
- unpacking the instrument 2.3
- update 3.2
- USB connector 1.7
 - external devices 2.13
- V**
- VBW (hardware setting) 4.5
- Vid (enhancement label) 4.8

W

warranty 2.4
Windows XP 2.24
 approved software 2.25
 service packs 2.26
 Start menu 2.26

Z

zero span measurements 5.22